

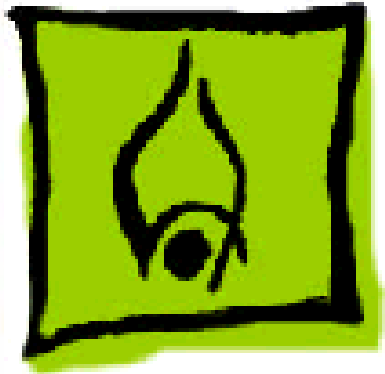

Power Macintosh G3 Desktop





Hot Issues

Power Macintosh G3 Desktop





Introduction

This chapter is designed to highlight unique or high-priority product issues that you should be aware of before servicing the Power Macintosh G3 Desktop computer.

This chapter alerts you to important issues and provides links to other areas in the manual where more complete information can be found. This chapter is not intended to replace other parts of this manual; it merely provides a pointer to pertinent information in those chapters.

To familiarize yourself with a new product family, always read the Basics chapter in its entirety.





Shared Logic Board

The Power Macintosh G3 Desktop and Minitower computers use the same logic board, but there are jumper settings that differ between them (see “Jumper Location J28” and “Jumper Location J16” in the Troubleshooting chapter).

Processor Module Vs. Card

Whereas previous Power Macintosh computers featured a user-installable processor card, this logic board uses a processor module that must not be removed by the customer (see “Processor Module” in the Take-Apart chapter).





Power Supply Jumper

The Power Macintosh G3 Desktop logic board has a power supply jumper, which is installed at J28. The setting of this jumper differs between the Power Mac G3 Desktop and Minitower. Failure to install this jumper in the correct position may result in a computer that won't boot up. (See “Jumper Location J28” in the Troubleshooting chapter.)

Processor Module Jumper

The Power Macintosh G3 Desktop logic board has a processor module jumper, which is installed at J16. The processor jumper is color coded for the speed of processor module used. Failure to install the correct jumper may result in a computer that won't boot up. (See “Jumper Location J16” in the Troubleshooting chapter.)





Warranty Sticker

There is a warranty sticker that covers the processor module jumper. The customer's warranty is void if this sticker is tampered with. Service Providers must replace this sticker if they have removed it during servicing to protect the customer's warranty. (See "Processor Module" in the Take-Apart chapter.)

Power Supply Voltage Setting

There is a switch on the back of the power supply that controls the voltage setting. The voltage switch **must** be set correctly to avoid damaging the computer. (See "Voltage Switch" in the Basics chapter for more information, including an international voltage chart.)





Voltage Regulator

There is a removable voltage regulator on the logic board, which comes with the logic board and can also be ordered as a separate module. (See “Voltage Regulator” in the Troubleshooting chapter.)

I/O Card

Some I/O functions on the logic board are handled through a removable I/O card that must be installed for the computer to operate properly. (See “I/O Cards” in the Troubleshooting chapter.)





ROM DIMM

The Power Macintosh G3 Desktop logic board uses a ROM DIMM as opposed to soldered ROM. You should not remove the ROM DIMM from the logic board. (See “Logic Board” in the Take-Apart chapter for instructions on how to prepare the logic board for return to Apple Computer.)

SDRAM DIMMs

The Power Macintosh G3 Desktop uses SDRAM DIMMs. DIMMs from older Macintosh computers, although they will fit, are not compatible and should never be used in the Power Macintosh G3 computers. (See “SDRAM DIMMs” in the Basics chapter and refer to the Power Macintosh G3 Desktop section of the Memory Guide.)





SGRAM Video Memory

Power Macintosh G3 computers use SGRAM video memory. Use only SGRAM SO-DIMMs in these machines. Never install the 256K or 512K video memory DIMMs used in older Macintosh computers. (See “SGRAM Video Memory” in the Basics chapter.)

EIDE Bus Issue

If you have only one device connected to the EIDE bus, the device must be plugged into the first EIDE connector on the logic board (the one closer to the rear panel), which is marked J9. If you plug the device into J10 and leave J9 empty, the device may not boot up. (See “Connecting EIDE Devices to the Logic Board” in the Basics chapter.)





Master/Slave Support

Some Power Macintosh G3 Desktop computers support adding two ATA/IDE devices to the same ATA/IDE channel, or what is commonly known as master and slave. This configuration provides user with the ability to add additional hard drives or removal media devices to their system. Because the cabling is different, you cannot replace ATA drives with SCSI drives and vice versa. (See “Support for Master and Slave” in the Basics chapter.)

Ultra Wide SCSI Cable Routing

The Ultra Wide SCSI cable (if present) must be routed inside the computer’s chassis in a very specific manner. Failure to route the cable correctly could result in performance problems. (See “Ultra Wide SCSI PCI Card” in





the Take-Apart chapter.)

DVD-ROM Disk Damage

The Power Macintosh G3 Desktop offers DVD-ROM drives as a build-to-order option. It is important to note that DVD disks are much more prone to damage than CD-ROM disks. Any type of scratch or other abuse may result in a disk that is unreadable. (See “DVD-ROM Drive Technology” in the Basics chapter.)

CD-ROM Ejection Problem

If you have a CD-ROM drive in a Power Mac G3 Desktop that fails to eject CDs properly, you may need to install poron bumpers. (See “CD-ROM Drive” in Troubleshooting.)





HFS+ Formatted Drives

Hard drives that ship with the Version 2 Power Macintosh G3 logic board (part number 661-2063) use a file format called Mac OS Extended format, also referred to as HFS+. Norton Utilities version 3.5 is not compatible with Mac OS and version 3.5.1 and earlier can result in hard drive corruption and loss of all data on the hard drive. If you experience problems with a hard drive in one of these systems, Apple Computer recommends using the version of Disk First Aid included on the system software CD that shipped with the unit. (See “HFS+ Formatted Drives” in the Troubleshooting chapter.)





Power-On Issue

If you experience a power-on issue with the Power Macintosh G3 Desktop where the power supply fan is spinning, but there is no boot tone, no hard drive noise, no power LED, and no video, you may have an improperly installed or faulty voltage regulator. You should always reseal and/or replace the voltage regulator before replacing the logic board. (See “System” symptom/cures in the Troubleshooting chapter.)





Basics

Power Macintosh G3 Desktop





Overview



The Power Macintosh G3 desktop chassis design allows you to access the logic board and its components, including the removable processor, without having to remove the power supply or any drives. This flexible design makes this computer easy to service and upgrade.

The Power Macintosh G3 desktop has a unique PERCH slot that accepts an I/O card that provides audio capabilities of the computer.



**Features of the Power Mac G3 Desktop include:**

- PowerPC G3 microprocessor running at 233 MHz, 266 MHz, or 300 MHz
- RAM expandable to 384 MB in 3 DIMM card slots using 64-bit 168-pin JEDEC-standard 3.3 V unbuffered SDRAM DIMM cards (Note: to expand to the maximum capacity of 384 MB requires low-profile DIMMs with maximum height of 1.15". Using higher-profile DIMMs with a height of 1.25", the maximum SDRAM capacity is 192 MB.)
- 512K backside L2 cache (233 or 266 MHz) or 1 MB backside L2 cache (300 MHz) on processor module
- Built-in 2D and 3D hardware graphics acceleration
- PERCH slot to support I/O card
- One modem slot on the I/O card for optional fax/modem card
- 4 GB or 6 GB ATA hard drive(s)





- Three expansion bays for adding internal 3.5-inch SCSI devices
- Optional 100 MB SCSI Iomega or ATAPI Zip drive in one of the expansion bays
- CD-ROM ATAPI drive at 24X speed (unless customer orders DVD-ROM drive)
- 1.4 MB SuperDrive
- One SCSI port
- Two GeoPort serial ports
- 10BASE-T Ethernet port
- One ADB port
- Three PCI expansion slots to accept
 - three 7-inch or 12-inch PCI cards, or
 - three 15 W cards, or
 - two 25 W cards
- Voltage switch
- Fan speed thermally controlled
- Energy Saver control panel





- 2 MB video RAM expandable to 4 MB or 6 MB with 3.3 V, 83 MHz or faster SGRAM on a 144-pin small outline dual inline memory module (SO-DIMM)

Optional Build-to-Order Power Mac G3 Desktop Features:

- ATAPI or SCSI Zip drive
- Ultra Wide SCSI PCI card
- 4 GB or 9 GB Ultra Wide 3.5" SCSI hard drive(s)
(replaces 4 GB or 6 GB ATA hard drive(s))
- DVD-ROM Drive (in place of CD-ROM drive)
- 10/100 BaseT ethernet card
- FireWire DVC card





Data Buses

The data buses on the Power Macintosh G3 Desktop include:

- **Narrow SCSI-1:** The SCSI-1 chain transfers data at up to 5 MB per second. The narrow SCSI-1 chain supports up to seven internal and external SCSI devices. The Narrow SCSI-1 bus is used to connect the ZIP drive (if present) and any SCSI-1 hard drives.
- **Ultra Wide SCSI-3** (provided on Ultra Wide SCSI card, which is optional): The Ultra Wide SCSI-3 chain can transfer data at up to 40 MB per second and supports up to three internal devices. This bus is used to connect any Ultra Wide SCSI devices.
- **EIDE (Extended Integrated Drive Electronics):** There are two EIDE connectors on the logic board (the ATAPI CD-ROM drive or DVD-ROM drive uses one of these connectors, and if an ATA hard drive is installed, it uses the second connector).





Note: Some Power Mac G3 system use a Master/Slave interface. See “Support for Master and Slave” later in this section for more information.

The following table gives more information about the data buses in the Power Macintosh G3 Desktop computer.



**Table 1: Internal Buses on G3 Desktop**

Interface	Connector Type	Notes	Max # of Drives	Max Data Transfer Rate
SCSI-3 ¹ (Ultra Wide)	68-Pin	Requires Ultra Wide SCSI PCI card.	2 ²	40 MB per second
EIDE	40-Pin	There are two EIDE connectors on the logic board.	2 ³	—
SCSI-2 ⁴ (Fast)	50-Pin	Requires Ultra Wide SCSI PCI card.	7	10 MB per second
SCSI-1 (Narrow)	50-Pin	Standard connector on logic board. Used to connect internal devices to Narrow SCSI-1 bus (e.g. ZIP drive).	7 ⁵	5 MB per second



**Notes for Table 1:**

- ¹ The Ultra Wide SCSI PCI card is optional on the G3 Desktop unit. The Apple Ultra Wide SCSI card and cable allow you to connect a maximum of 2 devices to this bus.
- ² Physical space inside the computer limits this number to 2.
- ³ The ATAPI CD-ROM drive, ATAPI DVD-ROM drive, and ATA hard drive (if present) use this bus.
- ⁴ Ultra Wide SCSI PCI card is optional on the G3 Desktop unit. It's best not to use this bus because it will cause any Ultra Wide SCSI-3 devices to transfer data at the slower SCSI-2 rate. No cable is provided for the SCSI-2 bus.
- ⁵ The G3 Desktop unit may come with a Zip drive attached to this bus. You can add additional SCSI-1 devices as long as the combined number of internal and external devices is no more than seven.





Narrow SCSI-1 Bus

All internal and external devices on the SCSI-1 chain must have unique ID numbers. SCSI ID numbers 0 through 6 are available. Always terminate the last internal and the last external SCSI-1 device.

Ultra Wide SCSI-3 Bus

Ultra Wide SCSI support is offered on the Power Macintosh G3 Desktop as an optional feature via an Ultra Wide SCSI PCI card (p/n 661-2011). If present, this card is installed in the first PCI slot on the logic board. You can connect a total of two internal devices to the Ultra Wide SCSI-3 bus.

Important: Before you connect an internal device to the Ultra Wide SCSI-3 bus, refer to the information on cable length limits and termination later in this section.





Important: Detailed information on how to route and tape the Ultra Wide SCSI cable can be found in the Take-Apart chapter in the Hard Drive topic.

All devices on the same SCSI bus must have unique ID numbers, but devices on different SCSI buses may use the same SCSI ID number. (For example, you could have a removable media drive with ID number 3 connected to the Narrow SCSI-1 bus and a hard drive with ID number 3 connected to the Ultra Wide SCSI-3 bus.)

Some of the drives that were installed at the factory, as well as the SCSI card itself, have already reserved certain SCSI ID numbers on the Ultra Wide SCSI-3 bus. Other ID numbers are available for assignment to SCSI devices that are added later.

The following table provides more information on assigning SCSI ID numbers to Ultra Wide devices.



**Table 2: Assigning Ultra Wide SCSI ID Numbers**

Ultra Wide SCSI ID #	Device
0	Factory-installed hard drive (terminated)
1	Factory-installed hard drive (optional)
2 — 6	Available (but not recommended)
7	SCSI PCI card (terminated)
8 —15	Available
Important: The factory-installed internal hard drive and the SCSI card are both terminated. Other SCSI devices you install and connect to the internal Ultra Wide SCSI-3 bus must not be terminated, or the computer will malfunction.	





EIDE Bus

The internal EIDE bus supports the internal CD-ROM or DVD-ROM drive. You can connect another EIDE device, such as an EIDE hard drive, to the second channel of the EIDE bus. (Note that in the standard G3 Desktop configuration, there is already an ATA hard drive attached to the second EIDE channel. Some build-to-order G3 Desktops, however, come with the optional Ultra Wide SCSI card and Ultra Wide SCSI hard drive, in which case the second EIDE channel is available.) You can install an EIDE device in one of the available expansion bays.

Connecting EIDE Devices to the Logic Board

There are two EIDE connectors on the G3 Desktop logic board, which are marked J9 and J10. Use the internal ribbon cable with the 40-pin connector to connect EIDE





devices to the EIDE bus.

If you are connecting a single device to the EIDE bus, you should use the J9 connector (the one closer to the rear panel). If you plug a single device into the J10 EIDE connector and leave J9 empty, the device may not boot.

If the Power Macintosh G3 Desktop ships with two EIDE devices (a CD-ROM or DVD-ROM drive and an ATA hard drive), both EIDE connectors (J9 and J10) will be automatically used. Service Providers should keep the J9 vs. J10 issue in mind, however, when testing G3 Desktop units.

Support for Master and Slave

Some Power Macintosh G3 Desktop computers support adding two ATA/IDE devices to the same ATA/IDE channel, or what is commonly known as master and slave. This configuration provides user with the ability to add additional





hard drives or removal media devices to their system.

The Power Macintosh G3 Desktop units that support this feature can only be identified by looking at the logic board itself and verifying the revision of the built-in video ASIC made by ATI Technologies. If you are looking at the logic board with the rear connector towards you, the video ASIC is located approximately 1" from the built-in video connector on the logic board.

If the ASIC reads: "ATI 3D Rage II+DVD," the logic board does not support the master and slave configuration; If the controller reads: "ATI 3D Rage Pro PCI," the logic board does support the master and slave configuration.

Note: Although the ATI chip is an ideal way to identify the version of the logic board, it does not control the EIDE interface.





Configuring or Connecting Master/Slave Devices

Each IDE channel can support either one or two devices. All Power Macintosh G3's have two ATA/IDE channels. ATA/IDE devices each contain their own integrated controllers, and so in order to maintain order on the channel, it is necessary to have some way of differentiating between the two devices. This is done by giving each device a designation as either master or slave, and then having the controller address commands and data to either one or the other. The drive that is the target of the command responds to it, and the other one remains silent.

Note: Despite the hierarchical-sounding names of "master" and "slave", the master drive does not have any special status compared to the slave one; they are really equals in most respects. The slave drive doesn't rely on the master drive or anything like that, despite the names.





Devices are designated as master or slave using jumpers, small connectors that fit over pairs of pins to program the drive through hardware. Each hard drive manufacturer uses a different combination of jumpers (usually named differently) for specifying whether its drive is master or slave on the channel. Some disks put this information right on the top label of the drive itself, while many do not; it sometimes takes some hunting around to find where the jumper pins are on the drive even once you know how the jumpers are supposed to go.

ATAPI drives, or ATA/IDE devices that support removable media like CD-ROM's are jumpered in exactly the same way, and they have the advantage of having their jumpers much more universally labeled than their hard disk counterparts.

If you are using two drives on a channel, it is important to ensure that they are jumpered correctly. Making both





drives the master, or both the slave will likely result in a very confused system.

Note: It makes no difference which connector on the ATA/IDE cable is used in a standard ATA/IDE setup, because it is the jumpers that control master and slave, not the cable. As long as one device is jumpered as master and the other as slave, any two ATA/IDE or ATAPI devices should work together on a single channel.





Ultra Wide SCSI Card

Ultra Wide SCSI support is offered on the Power Macintosh G3 Desktop as an optional feature via an Ultra Wide SCSI PCI card (p/n 661-2011). If present, this card is installed in the first PCI slot on the logic board.

Connecting Additional Internal Devices

If you add an internal drive to the Ultra Wide SCSI bus, you need to assign it a SCSI ID number in the 8 to 15 range. Devices assigned to numbers 2 through 6 may not work reliably.

Only internal SCSI devices may be attached to the primary Ultra Wide SCSI card; that is to say, you cannot use the external 68-pin connector on the card. To connect external Ultra Wide SCSI devices to the computer, you must install a





second Ultra Wide SCSI card.

To install a second Ultra Wide SCSI card, follow these guidelines:

- Use a single-channel card if possible.
- If you need to add a dual-channel Ultra Wide SCSI card, contact the PCI card vendor to verify compatibility with the Power Macintosh G3 Desktop.
- Do not use the Apple Ultra Wide SCSI PCI card (p/n 661-2011) as the second card unless it is shipped from the factory this way.

Specifications for the Ultra Wide SCSI Card

The Ultra Wide SCSI PCI card specifications are as follows:

- Automatic termination
- Advanced Data Streaming Technology (ADS)
- RAID Ready





- Embedded RISC I/P processor
- Ultra SCSI connector: Fine pitch 68-pin “P”
- Flash ROM BIOS
- PCI 2.1 compliant
- Large command FIFO
- Supports disconnect/reconnect
- Asynchronous I/O support
- Multiple initiator support
- SCSI-3 tagged command queuing
- SCSI Manager 4.3 compatible

SCSI-3 Bus

- Adapter interface: Special Bus management hardware for video, file servers, and real-time environments
- Maximum host transfer rate: 133 MB/sec.
- Maximum SCSI transfer rates: Synchronous data rate—40 MB/sec. per channel; asynchronous data rate—12 MB/sec.





- SCSI interface: SCSI-1, SCSI-2, SCSI-3, Ultra SCSI
- Electrical signals: Single-ended versions
- Extensive device support: Up to 105 Through Logical Unit Numbers (LUN's) (Wide and Narrow devices)

Cable Length Limits

When using Ultra SCSI single-ended devices, you can connect up to 8 devices if the total cable length is no longer than 1.5 meters (about 4.5 feet). If total cable length is between 1.5 meters and 3.0 meters (about 9 feet), you can connect only 4 SCSI devices. Error-free operation is not guaranteed if you exceed these limits.

When not using Ultra SCSI devices, SCSI specification limits total bus cable length for single-ended SCSI to 6 meters or approximately 18 feet (this is a combined figure of both internal and external cable lengths). You should keep cable





lengths as short as possible to ensure high signal quality and performance.

If you connect a combination of Wide 16-bit devices and Narrow 8-bit devices on the same connector (not recommended), Wide devices must be connected first (closest to the connector), followed by the Narrow devices. Refer to the documentation that came with your SCSI devices to determine if your device is Wide or Narrow, and if it is an Ultra SCSI device.





10/100 BaseT Ethernet Card

The specifications for the 10/100 BaseT ethernet card, which is an optional feature in the G3 Desktop, are as follows:

- Open Transport: Mac OS 8.1 or later, AppleShare, AppleTalk, NetWare for Macintosh, TCP-IP
- Connector: RJ-45 (for 10BaseT and 100BaseT)
- Media, 10BaseT: Cat 3, 4, or 5 UTP on 2 pairs up to 100M
- Media, 100BaseT: Cat 5 UTP on 2 pairs up to 100M
- Bus interface: PCI revision 2.0 and 2.1, share interrupt A
- Channel speeds: IEEE Auto Negotiation of 10BaseT and 100BaseTX
- Communications: IEEE 802.3u 100BaseTX; IEEE 802.3i 10BaseT
- Power: 1.2A @ 5V typical





- Controllers: DECchip 21140, 32-bit internal processor per channel





DVD-ROM Drive Technology

DVD stands for Digital Versatile Disc, an audio/video/data standard based on high-density next-generation optical discs. Apple Computer offers a DVD-ROM drive through the build-to-order (BTO) program which is capable of playing DVD-ROM disks.

Warning: DVD disks are much more prone to damage than CD-ROM disks. Any type of scratch or other abuse may result in a disk that is unreadable.

DVD Discs

The DVD Forum designed several standards for disk manufacture ranging from a single-sided, single-layer disk with 4.7 Gigabytes of data to a double-sided, double-layer disk with 17 Gigabytes of data stored on the disk.





DVD discs can hold nearly 26 times the amount of data that can be stored on a conventional CD. This capacity virtually eliminates the need to swap discs in the middle of a game or application and at the same time reduces the cost and the number of discs necessary to hold the data. The following table clearly illustrates the difference between CD and DVD storage possibilities.



**Table 3: Storage Capacities**

Disc Type	Diameter	Sides & Layers	Capacity	Playback Time (video)
CD-ROM	120mm	SS	650 MB	Max 74 min audio
DVD-5	120mm	SS/SL	4.7 GB	Over 2 hours of video
DVD-9	120mm	SS/DL	8.5 GB	Approx. 4 hours
DVD-10	120mm	DS/SL	9.4 GB	Approx. 4.5 hours
DVD-18	120mm	DS/DL	17 GB	Over 8 hours

Table Notes: SS=Single Sided, SL=Single Layer, DS=Double Sided, DL=Double Layered





To squeeze all this information onto the CD-sized disc, DVD disc designers: 1) made track spacing and the pits and lands used to record data nearly half the size of the original CD design; 2) made the discs double sided and added another data layer to each side creating a potential for four layers of data per disc.

The figure below illustrates the layers of a DVD disc.



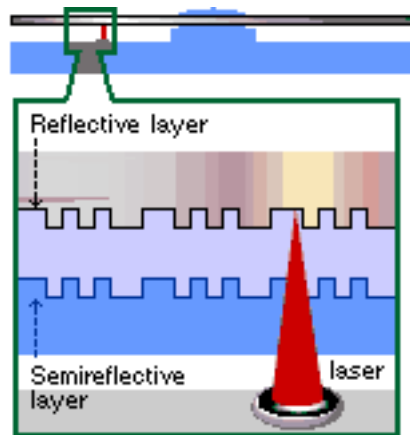

DVD Layers





Compared to CD, DVD uses smaller pits and a more closely spaced track. The result is a significant increase in data density. The higher Numerical Aperture (NA) lens of DVD helps the laser focus on the smaller pits.

Like CD, DVD is 120 mm (4-3/4 inches) in diameter. Like CD, DVD is 1.2 mm thick composed of (2) 0.6 mm substrates bonded together. The new DVD Players will be able to play existing music CDs.

The DVD standard defines a disc that maintains the overall dimensions, look and feel of the current Compact Disc. Some of these similarities will be unmistakable to customers experiencing DVD for the first time.



**Table 4: CD vs. DVD Comparison**

	CD	DVD
Disc Diameter	120mm	120mm
Disc Thickness	1.2mm	1.2mm
Disc Structure	Single substrate	Two bonded 0.6mm substrates
Laser Wavelength	780nm (infrared)	650 and 635nm (red)
Numerical Aperature	0.45	0.60
Track Pitch	1.6um	0.74um
Shortest Pit/Land Length	0.83um	0.4um



**Table 4: CD vs. DVD Comparison**

	CD	DVD
Data Layers	1	1 or 2
Data Capacity	Approx. 680 MB	Single Layer: 4.7 GBx2 Dual Layer: 8.5 GBx2
Data Transfer Rate	Mode 1: 153.6 KB/sec Mode 2: 176.4 KB/sec	1,108 KB/sec, nominal





Apple DVD-ROM Drive Specs

The Apple DVD-ROM Drive is an ATAPI drive. It uses an IDE port on the Macintosh for connection to the computer. Below are some of the specs for the drive. Note that the above transfer rate info varies from the data below. The numbers above reflect the DVD specification where the below numbers are for the drive that Apple is shipping.

Access Times (including latency)

DVD 170 ms or faster typical

CD 100 ms or faster typical

Data Capacity

DVD maximum 17 GB 256K Buffer





Transfer Rate

DVD: 2,705 KB/second

CD Mode 1: 1,293 to 3,000 KB/second

CD Mode 2: 1,474 to 3,429 KB/second

Disk Format Support

DVD 9660 Bridge (DVD-ROM Book, DVD-Video Book) Red-Book, Yellow-Book, CD-ROM XA, DA-I Bridge, Photo-CD, Video CD, CD-I Ready, CD-G, Multi-session (Photo-CD, CD Extra)

Note: To be able to play the DVD-Video disks, you must have an additional PCI decoder card installed that will allow the playback of movie disks. This PCI card contains controllers that decode the MPEG-2 video and Dolby AC-3 audio tracks on the movie. Without the card, movies cannot be played. Because of this, the DVD-ROM drive is only intended for DVD-ROM disks. These are DVD disks that contain data just like CDs do currently. If you wish to play DVD Video disks,





you will need to purchase a PCI decoder card.

DVD Software Drivers



Apple DVD-ROM



UDF Volume Access

These two extensions will allow a DVD disk to be mounted on the desktop. DVD disks use a format called universal disk format (UDF) to store data on the disks. All DVD disks are formatted UDF; this includes DVD-VIDEO and DVD-ROM disks.





File Management System Micro UDF & ISO9660

Universal Disk Format (UDF) is a file system standard that supports both rewritable and write-once media. It is a cross-platform data format that allows transparent interchange of data via optical discs or CD-ROMs. UDF also defines methods for reading, writing and other operations. Discs that are read on a Mac OS-based computer may also be read on a DOS, UNIX or Windows based computer. The format can coexist with CD-ROM data format (ISO 9660) but also incorporates the International Standards Organization interchange standard for rewritable and write-once media (ISO 13346) thus providing support for CD-Recordable discs (CD-R).

Before UDF was available, every CD-Recordable drive used a proprietary format of writing data, which prevents the ability to interchange files. Fortunately, most drives





supported either software or hardware updates to allow the drive to be upgraded so that it could write UDF. The first generation of DVD drives could not read CD-R media and in some cases actually damaged the media.

UDF Features

- Enables operating system independent interchange on optical media.
- Designed to support the massive capacities of optical jukeboxes.
- Only ISO standard file system for WORM media (Write Once Read Many).
- Industry selected file system for second generation (high capacity) CD-ROM.
- Industry selected file system for DVD.
- Enables full interchange between computer-based and entertainment-based media.
- Endorsed by world leading optical manufacturers.





Stand-alone players use UDF while computer applications use the UDF bridge format, which consists of both ISO-9660 CD-ROM format and UDF.





FireWire Technology

This section explains what FireWire technology is and gives specific information on Apple Computer's FireWire card, which ships as an optional build-to-order module on the Power Macintosh G3 Desktop.

FireWire Defined

FireWire technology refers to Apple Computer's cross-platform implementation of the high-speed serial data bus (defined by IEEE Standard 1394-1995) that can move large amounts of data between computers and peripheral devices.

FireWire is:

- A digital interface - no need to convert digital data into analog for better signal integrity





- A physically small thin serial cable - replaces today's bulky and expensive interfaces
- Easy to use - no need for terminators, device IDs, screws, or complicated set-ups
- Hot pluggable - devices can be added and removed while the bus is active
- Scalable - the Standard defines 100, 200, and 400 Mbps devices and can support the multiple speeds on a single bus
- Flexible - the Standard supports freeform daisy chaining and branching for peer-to-peer implementations
- Fast, guaranteed bandwidth - the Standard supports guaranteed delivery of time critical data which enables smaller buffers (lower cost)
- Non-proprietary - no licensing problems, adoption is encouraged





FireWire technology speeds up the movement of multimedia data and large files and enables the connection of digital consumer products -- including digital camcorders, digital video tapes, digital video disks, set-top boxes, and music systems -- directly to a personal computer.

Devices can be connected in any combination of branching and chaining, as long as no loops are formed. A FireWire bus can support up to 16 consecutive cable hops of 4.5 meters each. There are no SCSI-style ID numbers to set and no termination requirements.

FireWire supports two types of data transfer: asynchronous and isochronous. For traditional computer memory-mapped, load and store applications, asynchronous transfer is appropriate and adequate; but, one of FireWire's key features is its support of isochronous data channels.





Isochronous data transfer provides guaranteed data transport at a pre-determined rate. This is especially important for multimedia applications where uninterrupted transport of time-critical data and just-in-time delivery reduce the need for costly buffering. This leads to perhaps one of the most important uses of FireWire as the digital interface for consumer electronics and AV peripherals.

FireWire is a peer-to-peer interface. This allows dubbing from one camcorder to another without a computer. It also allows multiple computers to share a given peripheral without any special support in the peripheral or the computers. It is a result of all of these features that FireWire has become the digital interface of choice and its acceptance is growing.

In the world of video editing, FireWire enabled cameras remove the need for costly analog video computer frame





buffers to capture digital video. FireWire will gradually improve upon existing interfaces such as SCSI. FireWire provides higher speed, lower cost, and is more user friendly than most existing interfaces. SCSI products such as scanners, CDROMs, disk drives, and printers are already evaluating when they will move to FireWire.

FireWire has the bandwidth capacity to replace and consolidate most other peripheral connection communication methods in use today. Hot plugging, power sourcing, and dynamic reconfiguration make FireWire a user-friendly alternative to today's interconnects. These features will allow "plugging in" of computer peripherals as easily as plugging in a home appliance.

The Apple FireWire Digital Video Camera Card

The optional Apple FireWire Digital Video Camera (DVC)





card is Apple Computer's first implementation of FireWire technology. This card is designed to work with digital video camcorders and decks that use the DV format and have a FireWire port (sometimes marked IEEE 1394 or DV IN/OUT).

The FireWire DVC hardware and software, together with a non-linear editing application, allow the user to capture DV movie clips to their hard disk. They can view the clips in MoviePlayer or other QuickTime 3.0 applications, and edit and render the DV movies.

If the user has a video editing application with an export function, they can send (print or record) movies back to the tape in their camcorder or deck. The software also allows the FireWire device to be controlled from the computer.

The Apple FireWire DVC card installs in any available PCI slot on the Power Mac G3 Desktop logic board. It operates at





200 Mbps and supports a single digital video camera. The external FireWire cable, which ships with the card, connects any one of the 6-pin, external connectors on the card to a 4-pin connector on the digital video camera.

The Apple FireWire Card is designed to keep the network alive even if the Macintosh is shut down. Loss of power to the Macintosh will not affect the operation of a FireWire card as long as it can draw power from other cards on the bus. Each card provides power which is available to other devices on the network. This means that a system shutdown will not result in interrupted transmission over a FireWire network.

Important: For more information about cable management and power issues, please refer to the FireWire ReadMe file on the FireWire CD.





Connecting the FireWire DVC Card

The 6-pin connector on the external FireWire cable plugs into the card and the 4-pin connector plugs into the camera's DV port. Both connectors snap into place when properly engaged. A third-party cable is required in order to connect two computers together (or if the camera has a 6-pin FireWire port).



4-pin 15.9k (FireWire) connector



6-pin 15.9k (FireWire) connector

External FireWire Cable Connectors





Installing the FireWire Card Software

To install the Apple FireWire Card software:

- 1 Insert the FireWire CD.
- 2 Double-click the Installer icon.
- 3 Follow the on-screen instructions.
- 4 Restart the computer.

Important: An extension called FireWire Support may be located in a folder titled FireWire in the Apple Extras folder on the Macintosh. Do not move this older extension to the Extensions folder, as it may interfere with the operation of the new Apple FireWire software.





The Cuda Chip

The Cuda is a microcontroller chip. Its function is to

- Turn system power on and off
- Manage system resets from various commands
- Maintain parameter RAM (PRAM)
- Manage the Apple Desktop Bus (ADB)
- Manage the real-time clock

Many system problems can be resolved by resetting the Cuda chip (see Symptom Charts for examples). Press the Cuda reset button on the logic board to reset the Cuda chip. (See “Logic Board Diagram” later in this chapter to locate the Cuda reset button.) If you continue to experience system problems, refer to “Resetting the Logic Board” in this Basics chapter.





Resetting the Logic Board

Resetting the logic board can resolve many system problems (refer to “Symptom Charts” for examples). Whenever you have a unit that fails to power up, you should follow this procedure before replacing any modules.

- 1 Unplug the computer.
- 2 Remove the battery from the logic board.
- 3 Disconnect the power supply cable from the logic board and then press the Power On button. (See “Logic Board Diagram” later in this chapter to locate the Power On button.)
- 4 Wait at least 10 minutes before replacing the battery.
- 5 Make sure the battery is installed in the correct +/- direction.





6 Reassemble the computer and test the unit.

Note: This procedure resets the computer's PRAM. Be sure to check the computer's time/date and other system parameter settings afterwards.





Sound

The sound system for the Power Macintosh G3 computers is implemented entirely on the I/O cards. (There are two versions available.) Each supports 16-bit stereo sound output and input, available simultaneously.

The sound circuitry on the I/O card and system software can create sounds digitally and either play the sounds through speakers inside the enclosure or send the sound signals out through the sound output jacks. The sound circuitry digitizes and records sound as 16-bit samples. The computer can use 11.025K, or 22.050K, or 44.100K samples per second. The sound system plays samples at the sampling rate specified in the Monitors & Sound control panel.





The Power Macintosh G3 also records sound from several sources:

- A microphone connected to the line-level sound input jack
- A compact disc in the CD-ROM player
- Analog sound from the cross-platform card in a PCI slot
- Analog sound from optional communication cards

With each sound input source, sound playthrough can be enabled or disabled.





Sound Output

All sound output features for the Power Macintosh G3 computer are provided by an I/O card. The Audio I/O card (standard feature) provides one mini jack for sound output on the back of the enclosure. The AV I/O card (optional build-to-order feature) provides three sound output connectors—two RCA jacks for right and left sound out, and one 1/8-inch mini jack for a stereophonic phone plug.

The output jacks are connected to the sound amplifier. The mini jack is intended for connecting a pair of headphones or amplified external speakers. There is one built-in speaker. Inserting a plug into the sound output mini jack disconnects the internal speaker.





Sound Input

The I/O card provides a stereo sound input jack on the back of the enclosure for connecting an external Apple PlainTalk line-level microphone or other sound source pair of line-level signals. The sound input jack accepts a standard 1/8-inch stereophonic phone plug (two signals plus ground).

Note: The microphone for the Macintosh LC and LC II does not work with the I/O cards.

The AV I/O card provides an additional pair of RCA jacks for right and left sound input for an external source, such as a TV, VCR, or VTR.

Options in the Monitors & Sound control panel determine the interaction between the sound input and output devices. The sound circuitry normally operates in one of three modes:





- Sound playback—computer-generated sound is sent to the speaker and the sound output jacks.
- Sound playback with playthrough—computer sound and sound input are mixed and sent to the speakers and sound output jacks.
- Sound record with playthrough—input sound is recorded and also sent to the speakers and sound output jacks.





Video Input and Output

The AV I/O card (an optional build-to-order feature) supports video input and output of composite and S-video signals. The card supports input and output of NTSC, PAL, and SECAM video formats.

The AV I/O card accepts video from an external source and displays it in a window on the computer's display. The features of the video portion of the card include:

- Video display in a 320 X 240 pixel window
- Pixel expansion for 640 X 480 pixel maximum display
- Video overlay capability
- YUV format for digital video input
- A bi-directional digital audio video (DAV) connector for adding a video processor on a PCI expansion card





The card can accept video input from an external device, such as a VCR or camcorder.

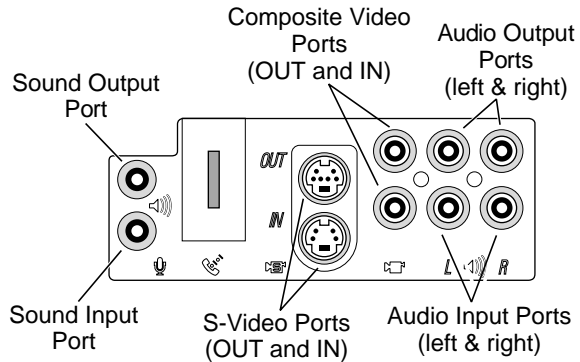

AV I/O Panel





The DAV Connector

The AV I/O Personality card has a digital audio video (DAV) connector. The DAV connector allows a PCI expansion card to access the AV I/O card video input data bus and associated control signals. The PCI card can use the digital video bus on the AV I/O card to transfer real-time video data to the computer. The PCI expansion card can contain a hardware video compressor or other video processor.

The DAV connector is a 60-pin flat-ribbon connector located at the top edge of the AV I/O card. A PCI expansion card can connect to the AV I/O card with a 7-inch 60-conductor flat-ribbon cable that is installed between the DAV connector and the PCI card. The DAV connector accepts YUV video and analog sound from the PCI expansion card.





Voltage Switch

The voltage switch must be set correctly to avoid damaging the computer. Insert a screw driver in the slot to set the switch to show “115” for voltages between 100 and 130. Set the switch to show “230” for voltages between 200 and 270. Some countries use two standardized voltages. If you aren’t sure which voltage is available, check with the electricity supply company before plugging in the computer.

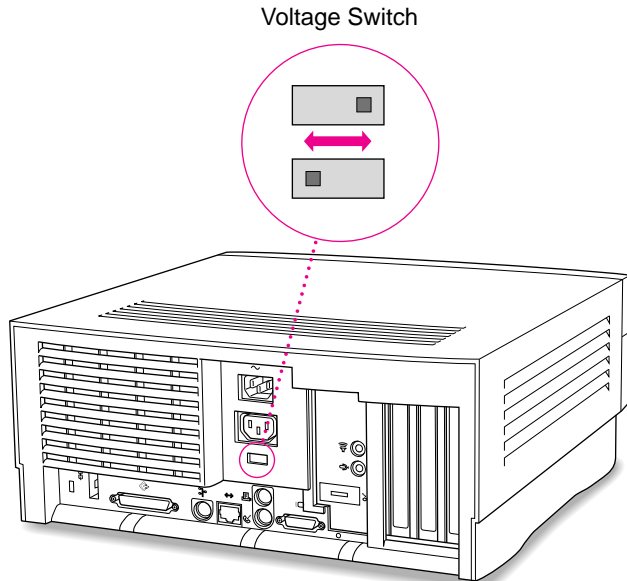



Here is a table listing voltages for some countries:

Country	Voltage
Japan	100
South Korea	100 or 220
Jamaica, Taiwan	110
Peru	110 or 220
Brazil, Lebanon	110-220
Philippines	115
Bermuda, Canada, Puerto Rico, United States, Venezuela	120
Mexico	127
Saudi Arabia	127 or 220
Hong Kong	200





Country	Voltage
India, South Africa	220-250
Israel, Pakistan, Singapore	230
Australia, Kuwait, Malta, New Zealand, Northern Ireland, Papua New Guinea, Oman, Qatar, United Kingdom	240
Austria, Belgium, Denmark, Finland, France, Germany, Greece, Italy, Luxembourg, Netherlands, Norway, Portugal, Spain, Sweden, Switzerland	220-230
Bahrain, Chile, China (People's Republic), Czechoslovakia, Egypt, Greenland, Hungary, Iceland, Iran, Jordan, Liechtenstein, Nepal, Paraguay, Poland, Romania, United Arab Emirates, Russia and the Commonwealth of Independent States (CIS), Yemen, Yugoslavia	220





PowerPC G3 and Backside Cache

Backside cache is a significant architectural design change from earlier PowerPC processors. The main advantage of the backside cache architecture is the speed of the dedicated CPU-to-L2 cache interface. Using the dedicated bus allows the CPU to access the fast L2 cache storage through a high speed bus without addressing the slower system bus or competing with other devices attached to the system bus. In comparison, a “far-side” cache running on the system bus would limit that SRAM interface to 50MHz.

The PowerPC G3 microprocessor interfaces with SRAM storage via a dedicated bus running at various multiples of the core PLL CPU speed. With high speed L2 SRAM and a dedicated L2 bus, the CPU can access stored information up to the speed of the processor clock. L2 access is determined by the clock ratio setting. For example, with a 250MHz





PowerPC G3, and a 2.5 L2 bus ratio, the backside cache bus speed will be 100MHz, twice the speed of the system bus.

SDRAM DIMMs

Three DRAM expansion slots on the logic board accept 3.3 V SDRAM unbuffered 8-byte DIMMs. The 168-pin DIMM has a 64-bit-wide data bus per bank. The minimum bank size supported on the Power Mac G3 Desktop model is 2 MB, and the largest is 32 MB. The largest DIMM supported is a two-bank DIMM of 64 MB using 32 Mbit SDRAM devices.

While the Power Mac G3 Desktop logic board supports a maximum RAM expansion of 384 MB, the 128 MB JEDEC industry-standard DIMMs are too tall to fit in the Desktop chassis. (The Power Mac G3 Desktop accommodates a DRAM DIMM height of 1.15 inches maximum.) Therefore, low-





profile DRAM DIMMs must be used to reach the maximum DRAM expansion of 384 MB. Using higher-profile DRAM DIMMs, the maximum DRAM expansion for the Power Mac G3 Desktop is 192 MB.

The DRAM DIMMs can be installed one or more at a time. The logic board supports only linear memory organization. Therefore, no performance gains are seen when two DIMMs of the same size are installed. Any supported size DIMM can be installed in any DIMM slot, and the combined memory of all the DIMMs installed will be configured as a contiguous array of memory.

Important: Power Macintosh G3 computers use SDRAM DIMMs. DIMMs from older Macintosh computers are not compatible and should not be used even though they fit into the Power Mac G3 DRAM DIMM slots.





SGRAM Video Memory

The Power Macintosh G3 logic board comes with 2 MB of Synchronous Graphic RAM (SGRAM) video memory soldered on. The logic board also contains a video memory expansion slot that accepts a Small Outline DIMM (SO-DIMM) to increase video memory up to a maximum of 6 MB. Apple supports a 4 MB SGRAM SO-DIMM that is 32-bit wide, 144-pin, fast-paged, 83 MHz/12 ns cycle time or faster.

Important: Use only SGRAM SO-DIMMs. Never use the 256K or 512K video memory DIMMs used in older Macintosh computers.





DIMM Slots

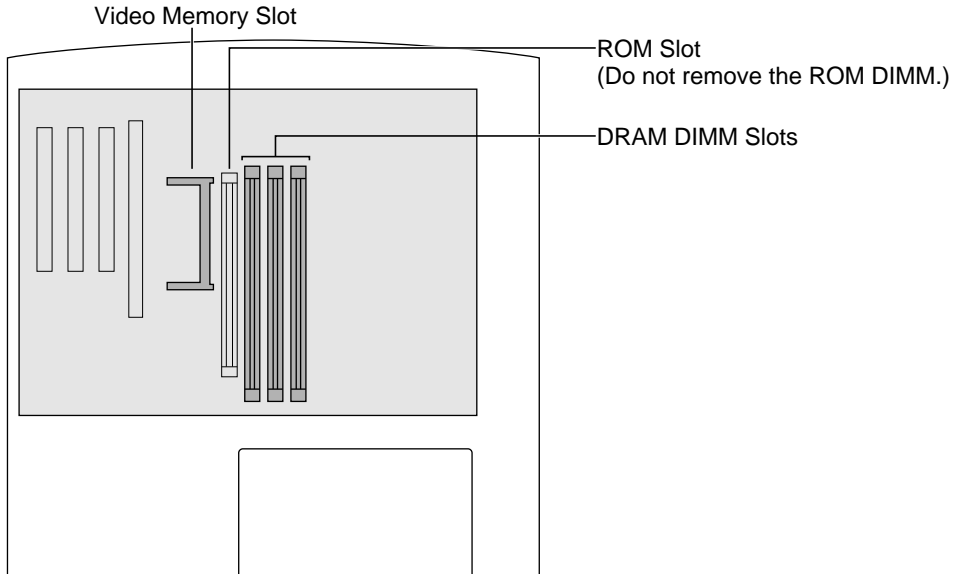



Peripheral Component Interconnect (PCI)

The Peripheral Component Interconnect (PCI) expansion slots accept 6.88-inch and 12.283-inch PCI cards. Because the PCI bus is an industry standard, most existing PCI 2.0-compliant cards (with the addition of a Mac OS-specific software driver) will work in these computers.

PCI offers significantly higher performance than the NuBus architecture used in previous Macintosh models. Running at 33 MHz, the PCI bus is up to three times faster than NuBus, offering overall enhanced system performance, particularly in the areas of video and networking.





Front View

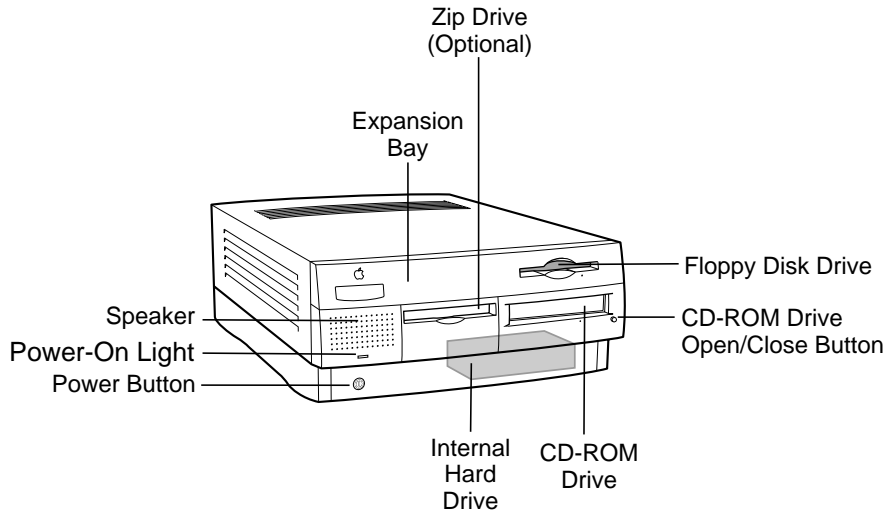



Rear View

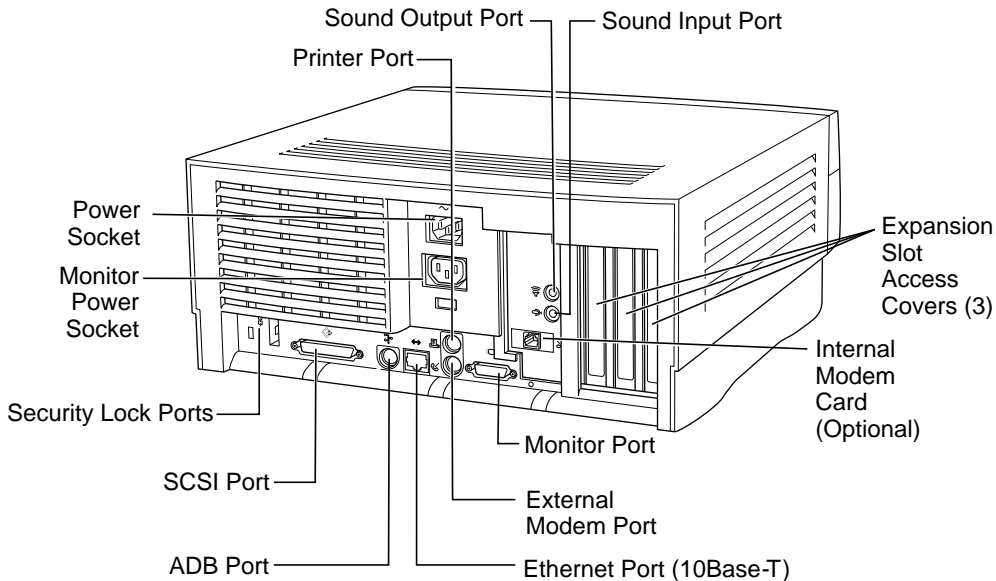



Internal Locator

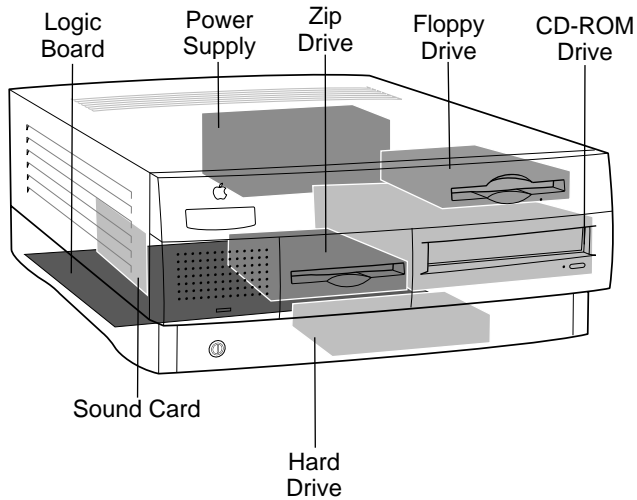



Logic Board

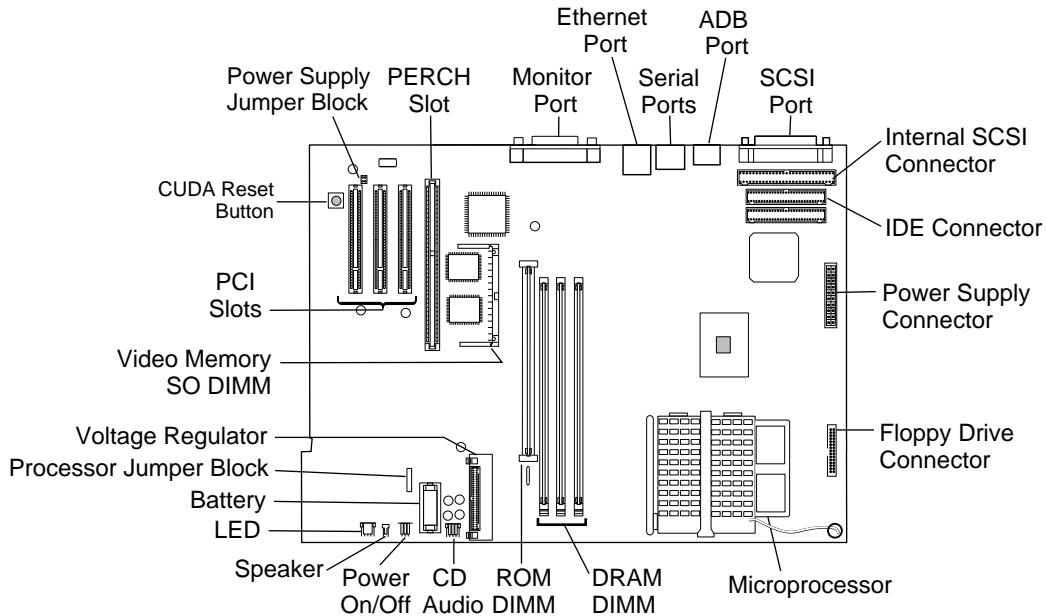



Repair Strategy

Service the Power Macintosh G3 Desktop computers through module exchange and parts replacement. Customers can request on-site service from an Apple Authorized Service Provider Plus (AASP+) Apple Assurance (US only), or Apple Canada Technical Answerline (Canada only). They can also choose carry-in service from an AASP.

Ordering

Apple Service Providers planning to support the computer systems covered in this manual may purchase Service modules and parts to develop servicing capability. To order parts, use the AppleOrder (US only) or ARIS (Canada only) system and refer to the Power Macintosh G3 “Service Price Pages.”





Large businesses, universities, and K-12 accounts must provide a purchase order on all transactions, including orders placed through the AppleOrder (US only) or ARIS (Canada only) system.

USA Ordering

US Service providers not enrolled in AppleOrder may fax their orders to Service Provider Support (512-908-8125) or mail them to

Apple Computer, Inc.
Service Provider Support
MS 212-SPS
Austin, TX 78714-9125

For US inquiries, please call Service Provider Support at 800-919-2775 and select option #1.





Canadian Ordering

Canadian Service providers not enrolled in ARIS may fax their orders to Service Provider Support in Canada (1-800-903-5284). For Canadian inquiries, please call Service Provider Support at 905-513-5782 and select option #3.





Warranty/AppleCare/ARIS

US Only

The Power Macintosh G3 computers are covered under the Apple One-Year Limited Warranty. The AppleCare Service Plan is also available for these products. Service Providers are reimbursed for warranty and AppleCare repairs made to these computers. For pricing information, refer to “Service Price Pages.”

Canada Only

The Power Macintosh G3 computers are covered under AppleCare. The Extended AppleCare Service Plan is also available for these products. Service Providers are reimbursed for warranty and AppleCare repairs made to these computers. For pricing information, refer to “Service Price Pages.”





The Power Macintosh G3 Series: Innovative Product Design for Affordable High Performance

A little background

Two decades ago, Apple made its name by bringing advanced technology to mainstream users through extraordinarily easy-to-use products. In particular, we gained a reputation for success in pioneering the educational use of computers and championing the advancement of multimedia technology.

Although that reputation has remained remarkably unchanged through the years—Apple is still regarded as the industry leader in both education and multimedia—the technology behind it has been altered practically beyond recognition, as have customer expectations. Today's mainstream computer users want affordable high-performance systems that provide outstanding communications and multimedia capabilities. The Power Macintosh G3 series was developed to satisfy that need—and to exceed customer expectations about price/performance value.

The Power Macintosh G3 series product design

When you talk about overall system design, you are really talking about a number of things—from the processor to the physical enclosure to the system software to the logic board—whose interrelationships are central to the user experience. The Power Macintosh G3 products were designed to meet the needs of our customers for performance, flexibility, and expandability through a streamlined development process in which a single logic board design provides a variety of capabilities. This approach simplifies testing, speeding development and increasing system reliability. In addition, the use of greater numbers of industry-standard parts than in previous Apple systems makes Power Macintosh G3 computers even more affordable.

Logic board. A computer's logic board design is the ultimate determinant of its functionality, involving such key features as processor, memory setup (controller and expansion capabilities), graphics support, and storage capabilities. The Power Macintosh G3 series systems use a mini-ATX board, which features, among other innovations, a faster system bus (66 megahertz as opposed to 50 megahertz, with room for further growth as processor speeds continue to increase) to support higher performance. This relatively tiny board, roughly the size of this fact sheet, allows for outstanding expandability—for example, by permitting the hard disk drive to fit within the base of the desktop model, so that it can also easily accommodate a Zip drive. In addition, it features an easy-to-access audio/video card slot that gives Apple the flexibility of offering a single product that provides a range of communications and multimedia capabilities to meet the varying needs of our users. For example, the Power Macintosh G3 is currently available in two versions: one system with stereo-quality audio capabilities and the other a full-featured, multimedia-optimized computer that also provides video-input/output capabilities and is suitable for content authoring.

Enclosure. The board's efficient use of space is also the key to our ability to use the same logic board in two very different physical enclosures. The Power Macintosh G3 series is currently available in a sleek, low-lying desktop model and a convenient, space-saving minitower. Both enclosures reflect Apple's tradition of user-centered design—offering exceptionally easy access to the board for expansion and servicing.

System software. These systems run Apple's latest and already outstandingly successful system software: Mac OS 8. Providing significant enhancements in the areas of user interface (including true multitasking and virtual memory capabilities) and Internet access and publishing (including integrated support for Java, and software tools that let users easily publish information on the Internet or a local intranet), Mac OS 8 has quickly gained a reputation for providing the industry's best overall user experience.

<http://www.apple.com>

In addition, the logic board design of the Power Macintosh G3 systems exhibits the following characteristics in these vital areas:

Processor. These computers use the innovative, next-generation PowerPC G3 processor, which was designed specifically to provide increased power at affordable cost. It does so through three major innovations: a state-of-the-art 0.25-micron manufacturing process, optimization for the Mac OS, and a new, more efficient approach to level 2 cache known as backside cache. Backside cache boosts performance far above the performance of earlier systems—even those with higher clock speeds—by positioning the cache directly on the processor module and making it directly accessible through a faster, dedicated bus. This bus can run at varying speeds in proportion to the processor speed. So, for example, the Power Macintosh G3 system based on a 266-megahertz PowerPC G3 processor features a 133-megahertz dedicated backside bus—more than twice the speed of the system bus.

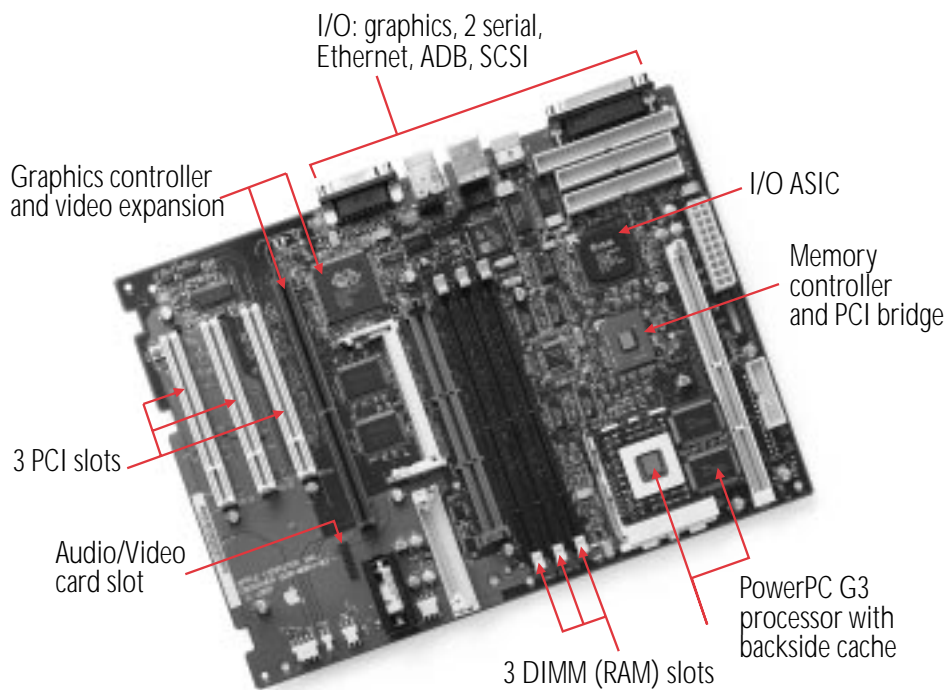

Memory. The memory controller and PCI bridge support the Power Macintosh G3 systems' three memory slots and three PCI expansion slots. These systems make use of a faster, industry-standard memory, SDRAM, which adds to both their economy and their availability.

Graphics controller. The Power Macintosh G3 series systems incorporate an ATI RAGE II + graphics controller, which not only provides outstanding performance, but also enables far greater expandability (2MB to 6MB) than was previously available, so users can choose the level of graphics performance that meets their needs.

I/O ASIC. This component provides support for the input and output of all standard Macintosh

graphics functionality and Apple Desktop Bus (ADB), serial, and SCSI connections. It also efficiently incorporates 10BASE-T Ethernet, to meet users' growing demands for easy and immediate access to high-performance networking capabilities.

The "why"

The motivation behind this innovative product design is the same simple idea that drives all of Apple's efforts: bringing truly outstanding computing performance to our users more and more easily and economically. So when you're looking for the computer that's just right for you, don't just look at the numbers (things such as processor speed and hard disk capacity). Because today, it's more important than ever to consider *overall* product design.

Apple Computer, Inc. 1 Infinite Loop Cupertino, CA 95014 (408) 996-1010 www.apple.com

© 1997 Apple Computer, Inc. All rights reserved. Apple, the Apple logo, Mac, Macintosh, and Power Macintosh are trademarks of Apple Computer, Inc., registered in the U.S.A. and other countries. Java is a trademark or registered trademark of Sun Microsystems, Inc. in the U.S.A. and other countries. PowerPC is a trademark of International Business Machines Corporation, used under license therefrom. Other product and company names mentioned herein may be trademarks of their respective companies.

November 1997. Product specifications are subject to change without notice. Printed in the U.S.A.

L02589A



The PowerPC G3 Processor: Taking the Macintosh to the Next Level

A little background

Nearly six years ago, Apple, IBM, and Motorola joined forces to create a new processor technology that would bring the performance advantages of the RISC (Reduced Instruction Set Computing) architecture—at that time limited to costly workstations—to personal computers. The result of this initiative was the development of PowerPC processor technology, which Apple debuted in 1994 with the introduction of the Power Macintosh line.

The initial Power Macintosh models were based on the first implementation of the new chip technology: the PowerPC 601, which was intended for use in high-end personal computers. In early 1995, Apple introduced products based on the PowerPC processor technology's second generation—the PowerPC 603, which utilized a chip design optimized for use in low-end to midrange desktop systems and portables. This was quickly followed by the introduction of the second-generation high-end PowerPC processor: the PowerPC 604. Since then, both IBM and Motorola have made enhancements to the PowerPC 603 and 604 (now the 603e and 604e), and these enhanced chips have been used in subsequent Apple systems.

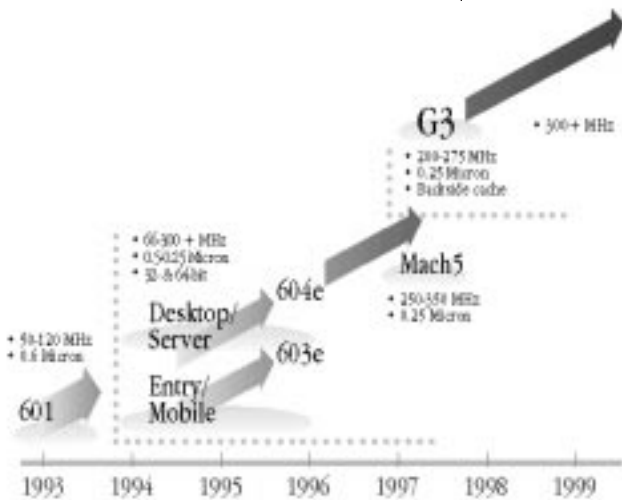

PowerPC Processor Roadmap

A roadmap for the development of PowerPC processor technology, from its inception to the end of the century.

The PowerPC G3 performance story

The emergence of the PowerPC G3 processor marks the third phase in the development of this advanced processor technology. Touted by *Microprocessor Report* (February 17, 1997) as “an outstanding combination of high performance and low cost,” the PowerPC G3 builds on many of the features pioneered by the PowerPC 603 and 604. However, this innovative chip differs from the earlier implementations of PowerPC processor technology in several significant ways:

- The PowerPC G3 is the first processor specifically optimized for the Mac OS.
- It incorporates an innovative backside cache design that speeds access to level 2 cache.
- It contains large (32K) on-chip level 1 data and instruction caches, for a total of 64K level 1 cache.
- It's produced using an industry-leading 0.25-micron manufacturing process.

PowerPC G3 optimization features include the following:

- Addition of a second integer ALU (arithmetic and logic unit), which allows the processor to execute two successive integer operations in parallel
- The ability to fetch four instructions per cycle from the cache
- A “hardware tablewalk” feature, which allows the CPU to access virtual page tables directly
- Adoption of a dynamic prediction method for improving the efficiency of branch handling

These four innovations share one very important characteristic: the capacity to provide significant performance gains. Following is a more detailed breakdown of the advantages offered by each.

Mac OS optimization. Because the earlier PowerPC processor models were essentially developed simultaneously with Apple's Power Macintosh line, there was no opportunity to optimize these chips' performance for running Mac OS-based applications. But that was more than half a decade ago. Today, the Power Macintosh line is well established and Mac OS-based software abounds, placing the developers of the PowerPC G3 processor in the unique position of having the luxury to consider—and optimize—chip design in light of actual software performance.

<http://www.apple.com>

Learning to look beyond megahertz

The performance enhancements of the PowerPC G3 processor significantly reduce the usefulness of clock speed in attempting to compare computer performance. Apple systems based on this processor consistently outperform systems with higher clock speeds—in fact, they also outperform Pentium II–based systems. Some examples follow.

- A 250-megahertz Macintosh PowerBook G3 is faster than a 266-megahertz Pentium II desktop.*
- A 233-megahertz Power Macintosh G3 is faster than the Power Macintosh 6500/300 and the Power Macintosh 8600/300.**
- A 266-megahertz Power Macintosh G3 provides performance that is on average 30 percent faster than that of a comparable 266-megahertz Pentium II system.*

All of which means that when you're looking for the computer that's right for you, it's more important than ever to consider overall product design—megahertz alone does not tell the whole story.

* Based on Apple internal tests running 15 separate Adobe Photoshop filters.

** Based on Apple internal testing using MacBench 4.0 processor performance scores. Actual performance on applications may vary. MacBench is a subsystem-level benchmark that measures the relative performance of Mac OS–based systems.

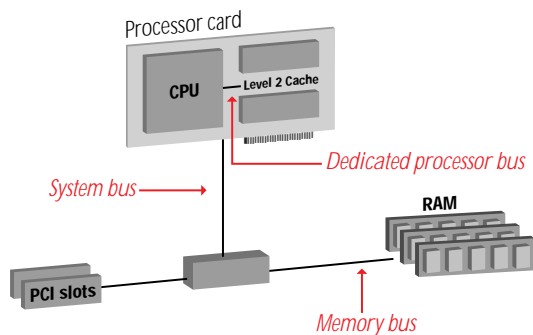

Backside Cache

The backside cache design allows the CPU to access the cache directly at speeds that vary proportionally to the CPU speed

Level 2 backside cache. By far the biggest boost to performance that the PowerPC G3 offers can be credited to its incorporation of an approach to level 2 cache memory known as backside cache. This approach effectively bypasses limitations on the speed at which transactions between the processor and the level 2 cache can occur. Earlier PowerPC processors used the system bus to access both the level 2 cache memory and the main memory, which could result in conflicts. For example, under the previous approach, at processor clock speeds above 200 megahertz, the CPU would often stall as it waited for data to arrive from the level 2 cache. To prevent such slowdowns, the PowerPC G3 processor features a new dedicated bus that handles only the CPU/cache transactions. This bus can operate at higher speeds than the system bus—speeds that relate incrementally to the clock speed of the processor. This enables the more effective use of level 2 cache, because even the relatively large amounts of data it can store can be accessed by the processor rapidly and efficiently. In fact, as clock speeds increase, so does the performance value offered by the backside cache design.

Large level 1 (on-chip) data and instruction caches. In comparison with the 8K on-chip caches incorporated into the design of the original PowerPC 603, the PowerPC G3 processor includes 32K of instruction cache and 32K of data cache, for a total of 64K level 1 cache. These relatively large on-chip caches support—and add to—the overall performance gains offered by the PowerPC G3 processor.

New manufacturing process. Finally, the industry-leading 0.25-micron process used to produce the PowerPC G3 processors does more than merely boost performance; it also enables the creation of smaller, cooler processors with extremely low power requirements. In essence, it represents a brand-new approach to chip design, one that brings workstation-class performance not only to desktop systems, but even to notebook computers—using the same processor.

Benefits to the user

As the PowerPC G3 processor becomes central to Apple system designs, increasing numbers of Macintosh users will enjoy these benefits:

- Significant performance gains, which enhance the power available to handle such resource-intensive tasks as video editing, Internet authoring, and Windows emulation through software alone, rather than requiring more costly and complex hardware add-ons
- Even more affordable higher performance—in particular, providing a radical improvement in the value proposition offered by our entry-level and midrange systems
- The ability to purchase a notebook system that can *truly* offer the performance of a desktop computer

The “why”

The rationale for Apple's introduction of the PowerPC G3 processor is strikingly simple. It's the same concept that led us to embark on the PowerPC effort initially: At Apple, we are committed to developing and supporting processor technology that can offer our entire range of users truly outstanding performance—so they can spend less time dealing with the mechanics of computing and more time exploring their creative potential.

Apple Computer, Inc. 1 Infinite Loop Cupertino, CA 95014 (408) 996-1010 www.apple.com

© 1997 Apple Computer, Inc. All rights reserved. Apple, the Apple logo, Mac, Macintosh, PowerBook, and Power Macintosh are trademarks of Apple Computer, Inc., registered in the U.S.A. and other countries. Adobe is a trademark of Adobe Systems Incorporated. PowerPC is a trademark of International Business Machines Corporation, used under license therefrom.

November 1997. Product specifications are subject to change without notice. Printed in the U.S.A.

L02588A



Specifications

Power Macintosh G3 Desktop





Introduction

Specifications information for this product can be found in the Spec Database, which you can access at Service Source Online (<http://service.info.apple.com>) or on Service Source CD.

Spec Database at Service Source Online

From the Service Source Online home page, click Troubleshoot and Repair to access the main repair procedures page. Then click either Apple Spec in the navigation table in the upper right corner of the page, or click Apple Spec Database from the list of reference tools below.

Spec Database on Service Source CD

Open the CD and double-click the Apple Spec Database alias located at the top level of the CD.





Take Apart

Power Macintosh G3 Desktop



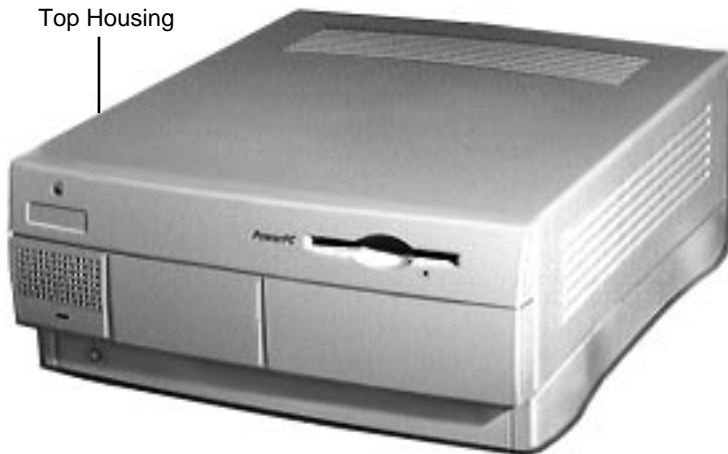

Top Housing

No preliminary steps are required before you begin this procedure.

Note: The top housing covers the top, front, and left and right sides of the computer.





- 1 Press the two tabs at the front corners of the top housing to release the top housing from the bottom chassis.





- 2 Pull the top housing forward about 1 to 2 inches and lift straight up to remove the top housing from the computer.





Bezels

Before you begin, remove the top housing.

Note: As you face the computer, the bezels are in the middle of the top housing's front panel. Depending on the unit, you may either see a blank bezel or a Zip drive bezel in the middle of the front panel, and you may have either a CD-ROM or a DVD-ROM bezel.



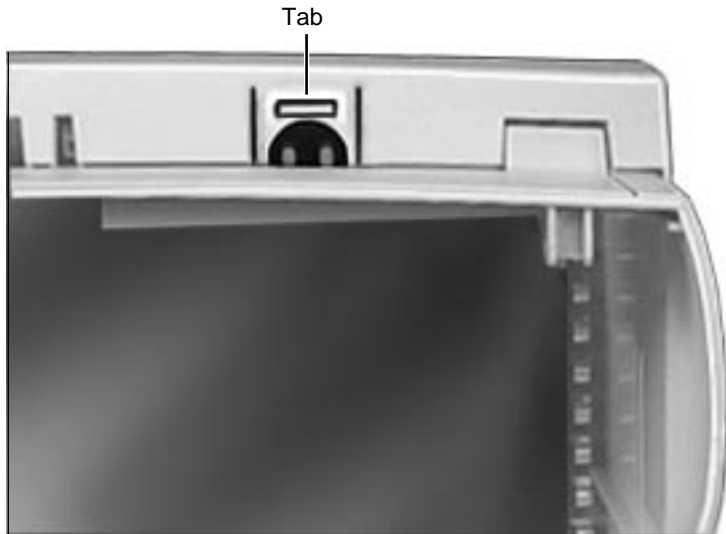

- 1 From the underside of the top housing, pull out on the moon-shaped opening at the bottom of the bezel to release the tab. Lift up the bezel to remove it from the top housing.





Chassis Latch

Before you begin, remove the top housing.

Note: The chassis latches mount in the internal chassis and secure the internal chassis to the external chassis frame.

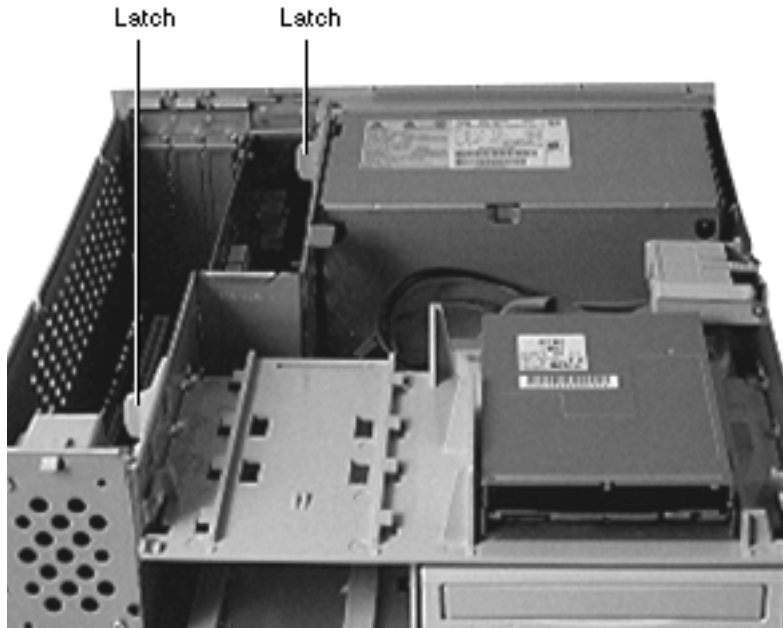

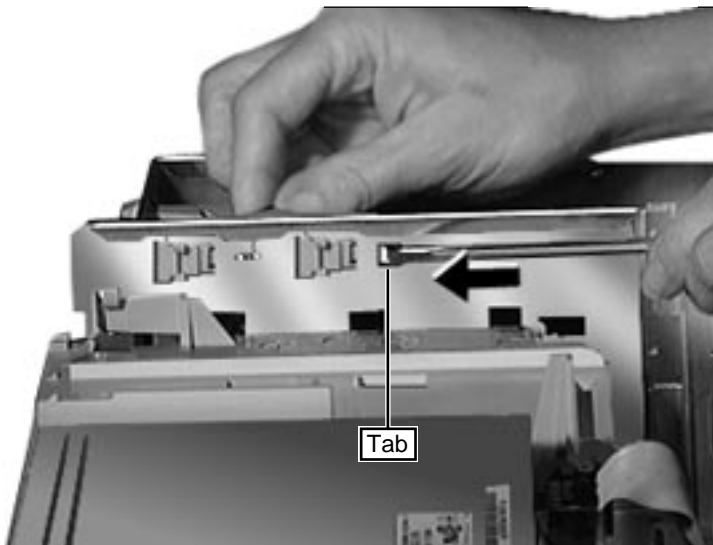

- 1 Use a screwdriver to push out the tab indicated in the illustration. Slide the latch forward and lift it from the chassis.



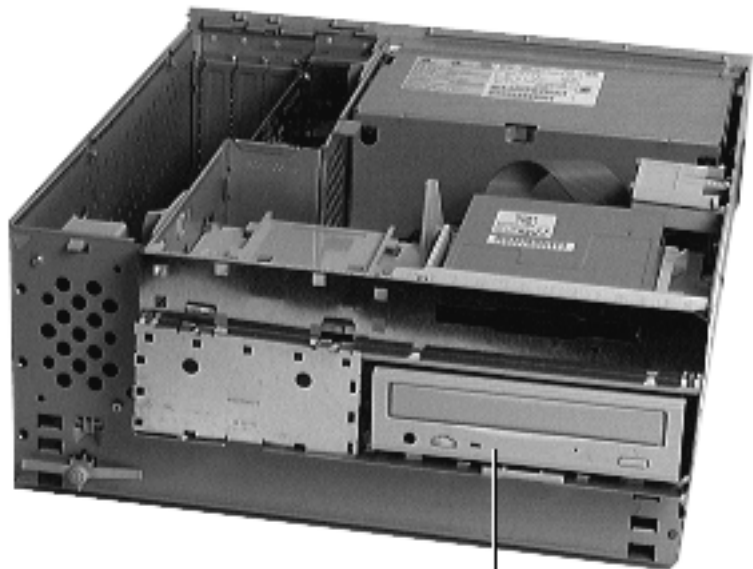

CD-ROM Drive

CD-ROM or DVD-ROM Drive

Before you begin:

- Remove top housing
- Remove CD-ROM or DVD-ROM EMI shield

Note: Special cable routing instructions for Master/ Slave IDE configurations can be found at the end of this section.

Replacement Note: Be sure the EMI shield doesn't interfere with the CD-ROM drive opening.





Power
Connector

SCSI
Connector

CD-ROM
Audio
Connector

- 1 Disconnect the SCSI data cable, power cable, and CD audio cable from the back of the CD-ROM or DVD-ROM drive.



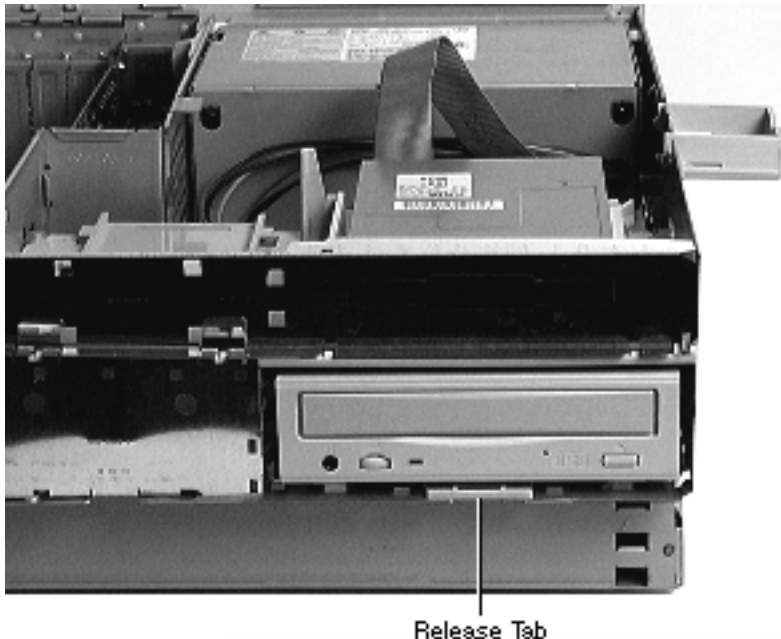

- 2 Pull up the release tab and slide the CD-ROM or DVD-ROM forward to remove it from the internal chassis.

Note: Be sure to remove the CD-ROM or DVD-ROM drive from its carrier before returning the drive to Apple.

Note: If you have an ultra wide hard drive installed in the unit, you must have a leaf gasket installed in between the right side of the CD-ROM drive and the internal drive chassis.





Replacement Note: When replacing the CD-ROM drive, you must install two or more poron bumpers (p/n 922-3554) at the rear of the CD-ROM carrier (i.e., where the carrier meets the metal chassis tabs when installed). Start by installing one bumper on each side of the carrier and test the CD eject function. If the CD exhibits ejection problems, you will need to install an additional bumper on top of each of the bumpers already in place. You may have to install up to three bumpers on each side to correct the problem, but be sure to test the CD eject function before installing additional bumpers.

Replacement Note: When replacing the CD-ROM drive, if there is a rubber foot (i.e. bumper) on the side of the drive that faces the outside of the chassis, you must install the foot on the replacement drive. (Note: this rubber foot reduces CD-ROM vibration.) If the adhesive is worn out, you will need to order a new rubber foot (p/n 922-3678).





The following graphic shows the installation instructions.

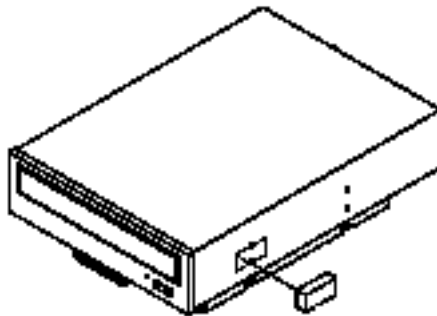

Place the rubber foot between the two screws as shown.



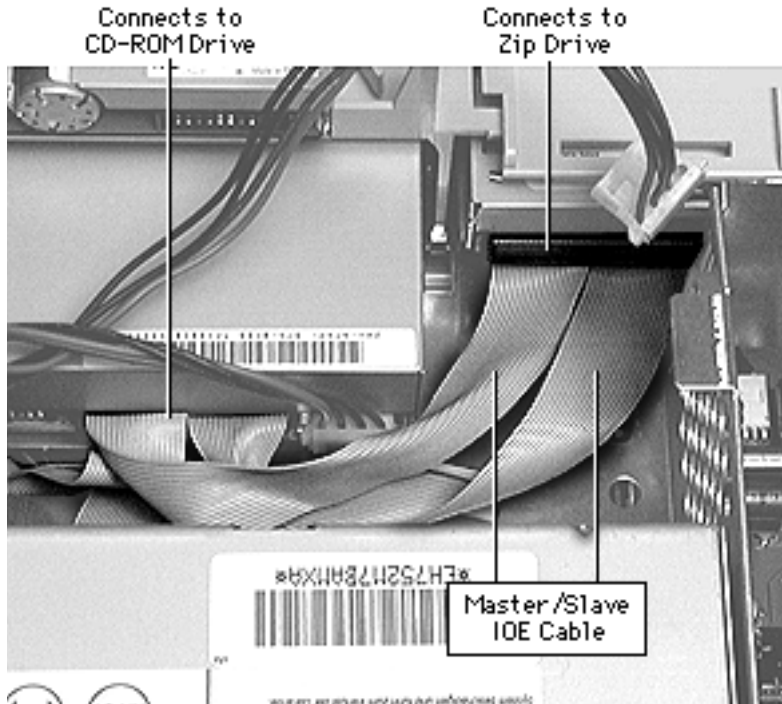

Master/Slave Cable Routing

Some G3 Desktop logic boards support master and slave IDE configurations, allowing you to connect two devices to a single IDE channel. These boards ship with a special split IDE cable that also supports master and slave configurations.

The graphic at left shows how the split master/slave IDE cable connects to the devices in the unit.



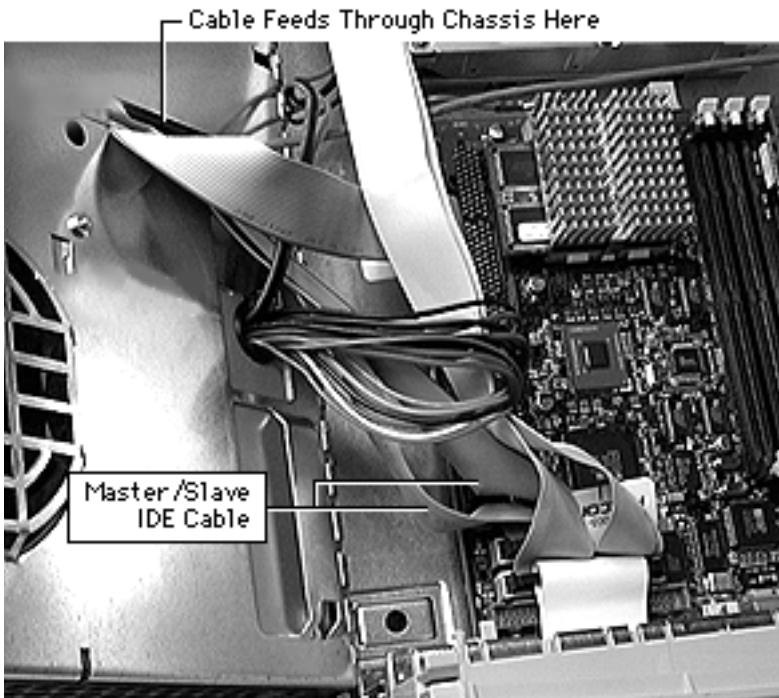

The graphic at left shows how the split master/slave IDE cable connects to the logic board. The same connector is used for both the regular IDE and the master/slave IDE cables.





Zip Drive

Before you begin:

- Remove top housing
- Remove Zip and CD/DVD EMI shield

Note: Special cable routing instructions for Master/ Slave IDE configurations can be found at the end of this section.

Replacement Note: Be sure you install the EMI shield carefully so that it doesn't interfere with the CD-ROM drive opening.

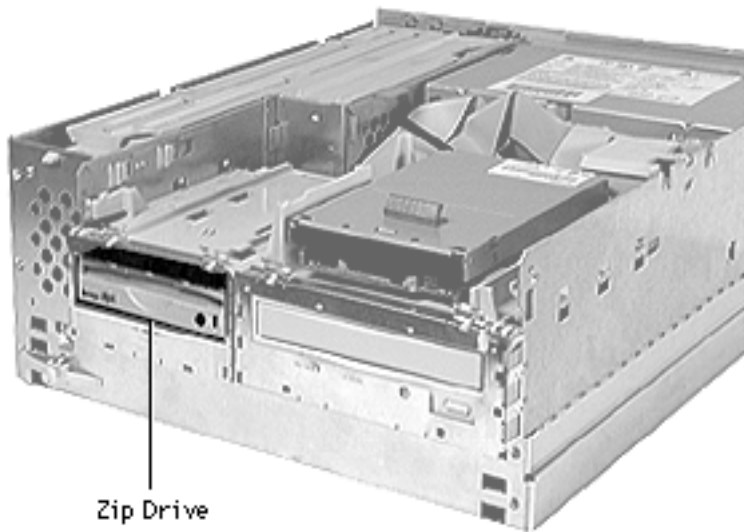

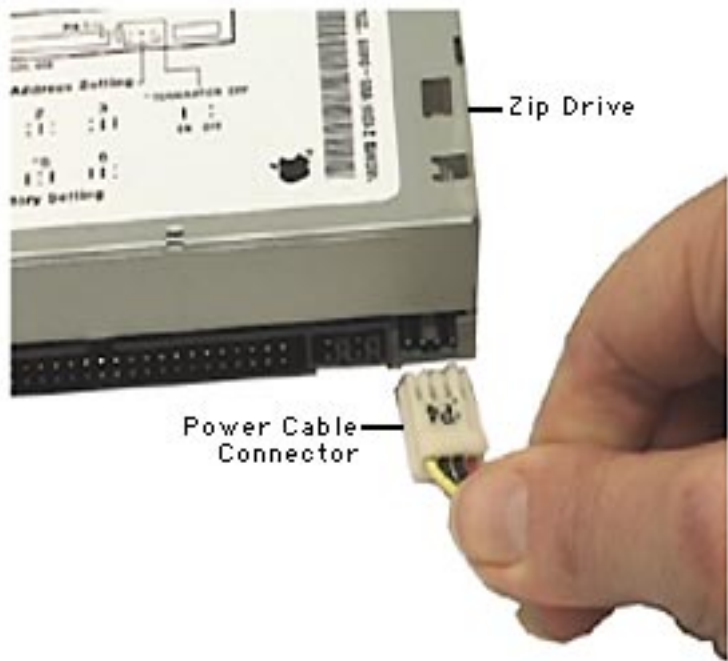

- 1 Disconnect the cable from the back of the Zip drive.

Caution: The power cable connector is a keyed connector. If it is removed with too much force, the keyed latch can break. With a broken latch, the connector can be installed incorrectly and cause the drive to fail. Reinsert the power cable connector with the metal contacts facing up, as shown.





- 2 Push up on the tab underneath the zip drive and slide the zip drive out of the chassis.

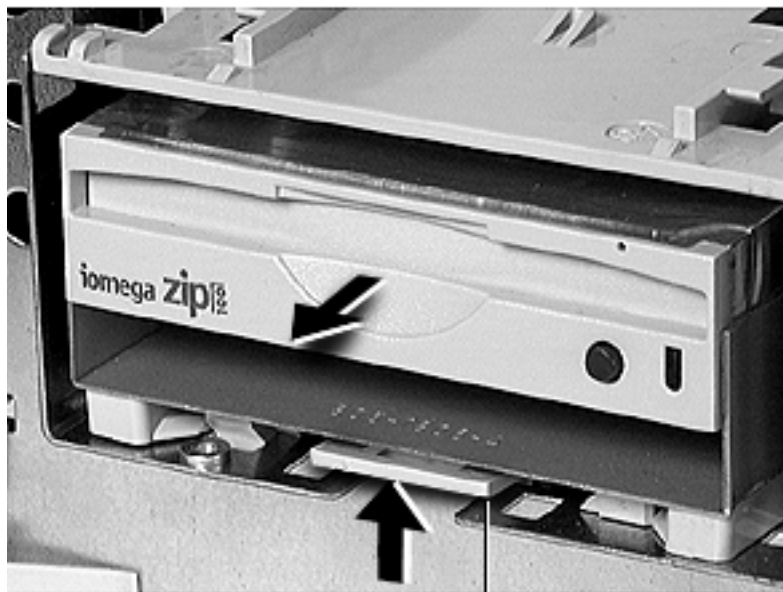

Tab



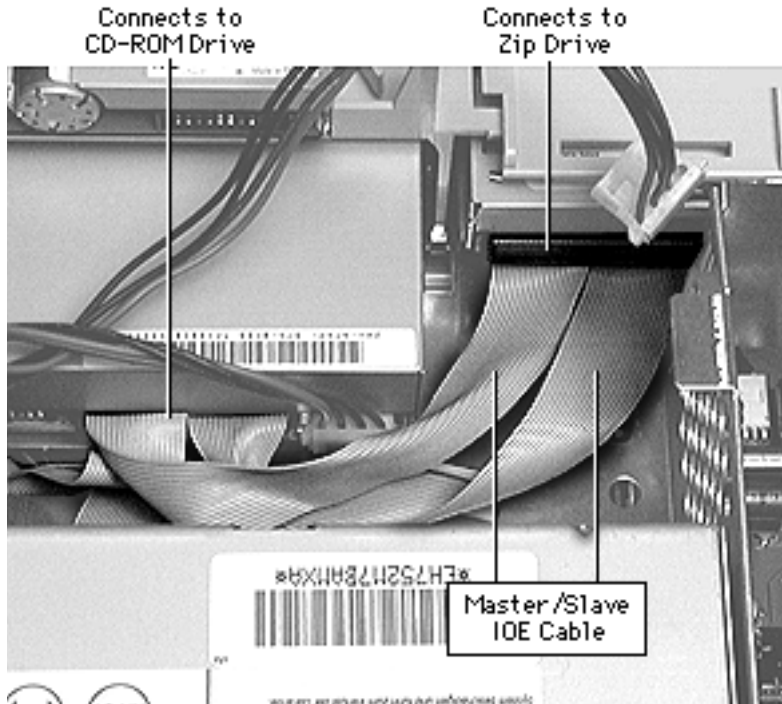

Master/Slave Cable Routing

Some G3 Desktop logic boards support master and slave IDE configurations, allowing you to connect two devices to a single IDE channel. These boards ship with a special split IDE cable that also supports master and slave configurations.

The graphic at left shows how the split master/slave IDE cable connects to the devices in the unit.



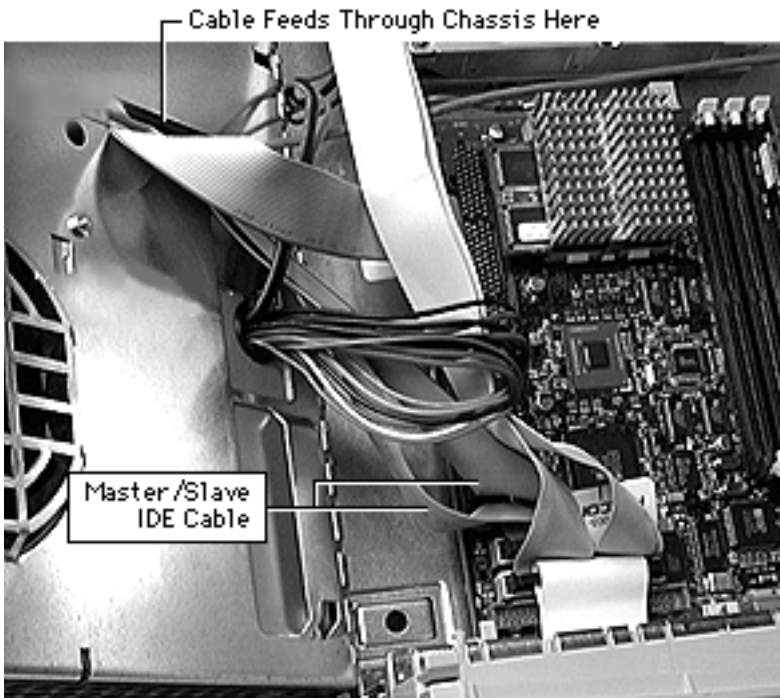

The graphic at left shows how the split master/slave IDE cable connects to the logic board. The same connector is used for both the regular IDE and the master/slave IDE cables.





Floppy Drive

Before you begin, remove the top housing.

Note: As you face the computer, the floppy drive is in the top right drive bay.

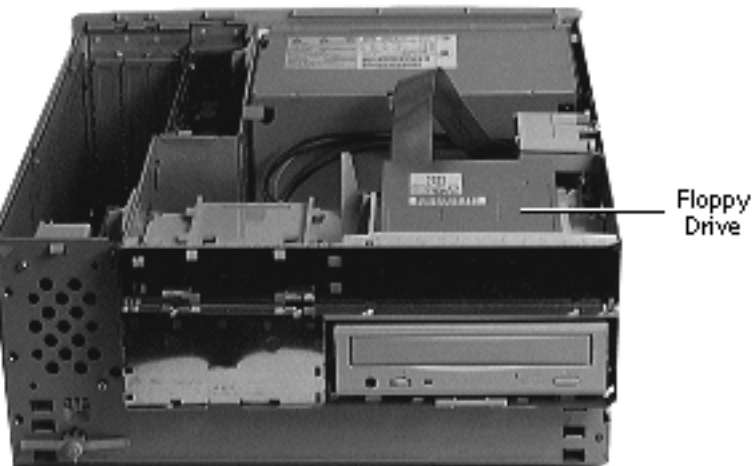



- 1 Remove the blank shield and the floppy drive shield from the front of the unit.

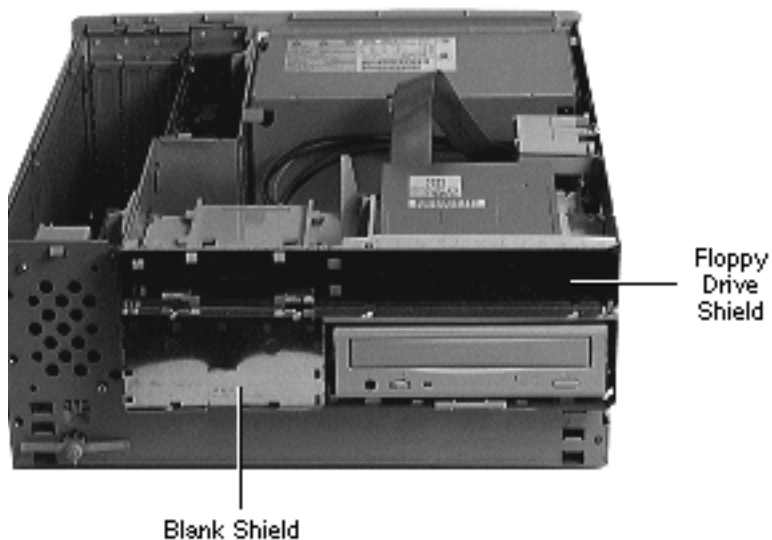



- 2 Flip open the chassis support foot.

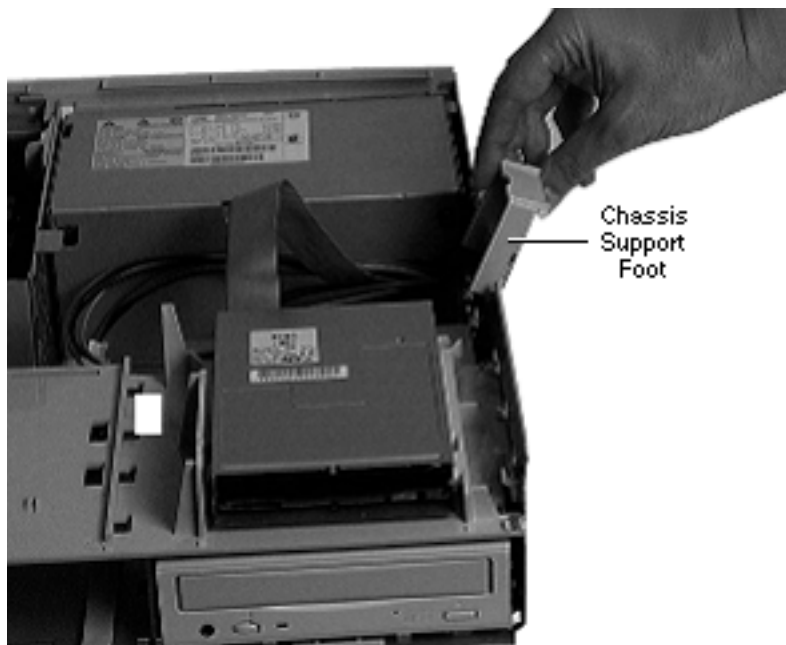



Floppy Drive Cable

Floppy Drive



- 3 Disconnect the floppy drive cable from the back of the floppy drive.



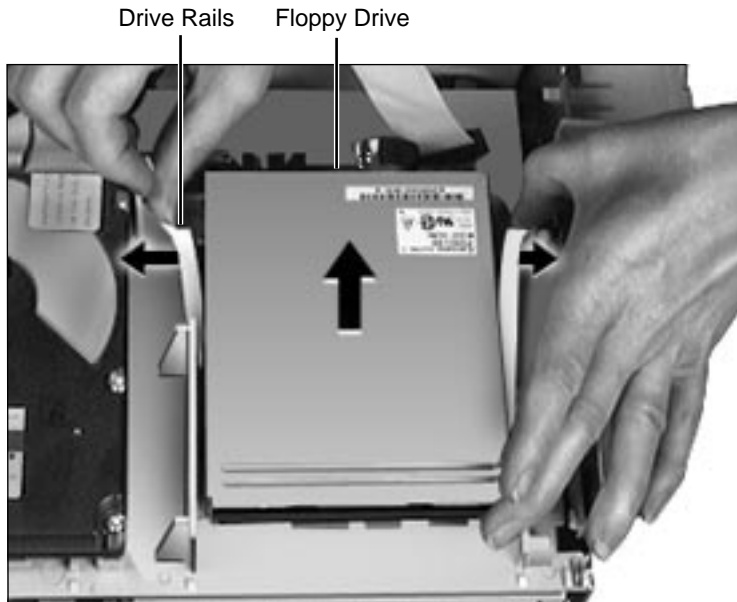

- 4 Pull out on the plastic drive rails that secure the floppy drive to the drive chassis and push back the drive to release it.



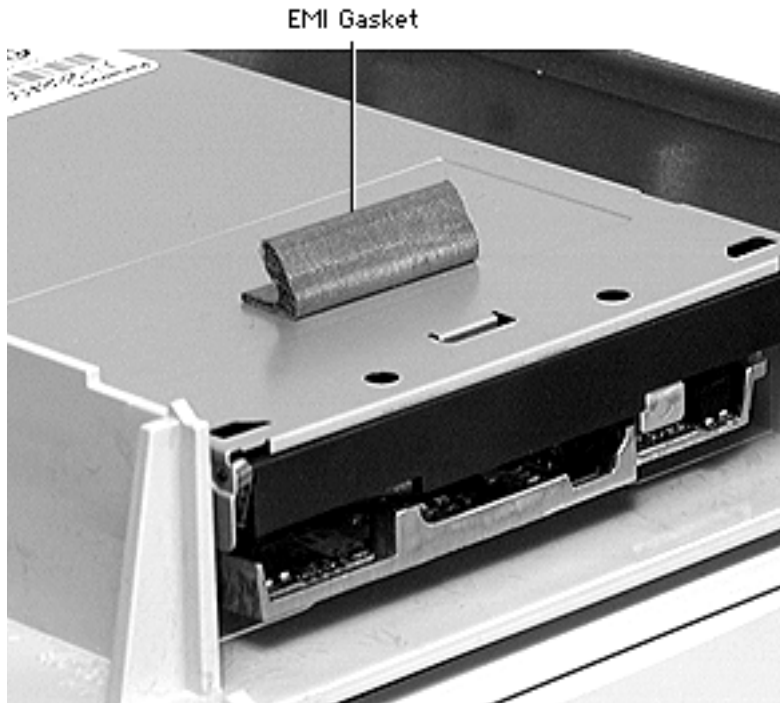

Replacement Note: If you are replacing the floppy drive, remove the EMI gasket from the defective drive and attach the gasket in the center of the replacement drive's top surface, with the "V" of the gasket pointing at the front edge of the drive. If the old gasket won't stick, order a new gasket (p/n 922-1895).





Drive Chassis

Before you begin, remove the top housing.

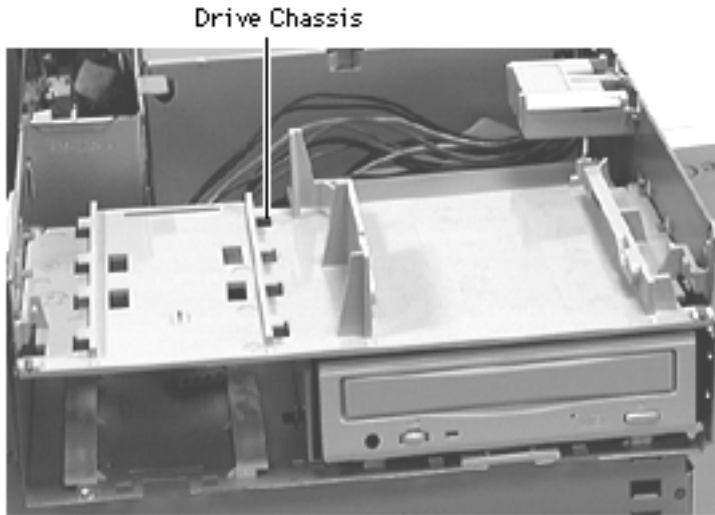

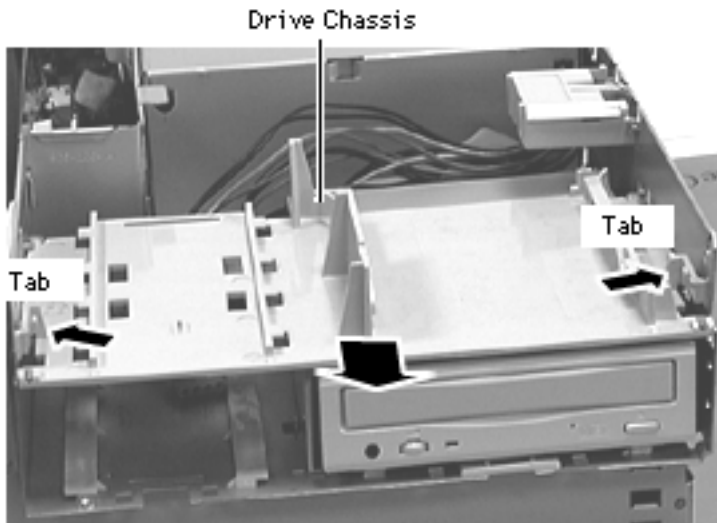

- 1 Push in on the two tabs securing the drive bracket to the internal chassis and slide the drive bracket out to remove it.



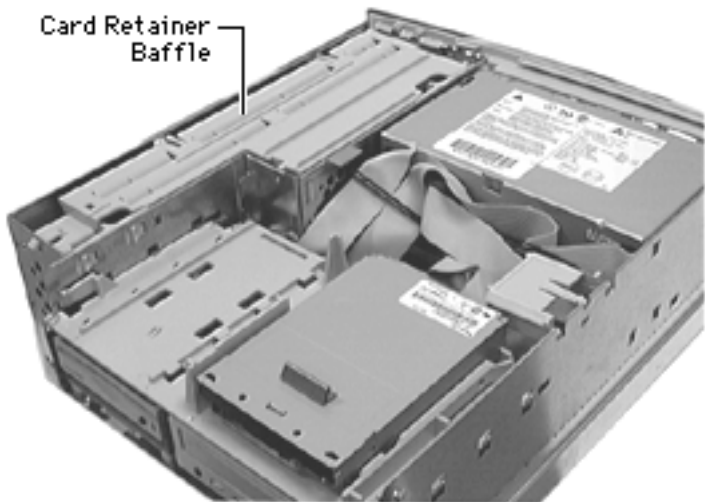

Open/Remove Card Retainer Baffle

Before you begin, remove
the top housing.



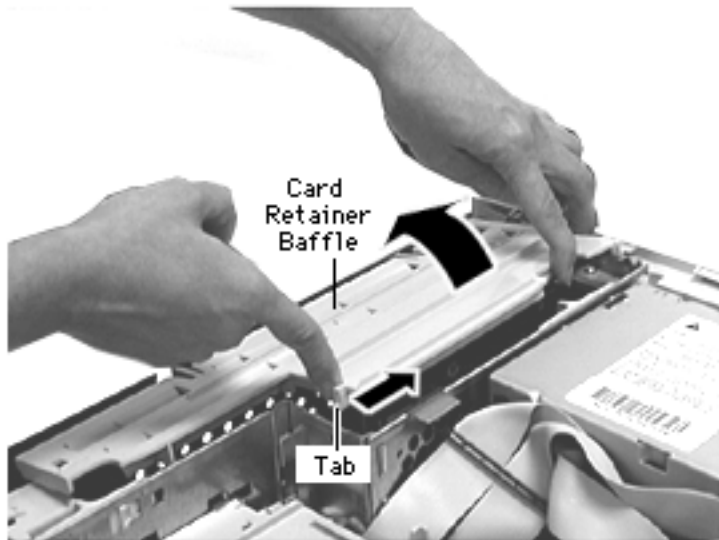

To Open the Card Retainer Baffle:

- 1 With one hand lift up on the baffle while, with the other hand, pushing in on the tab that secures the baffle to the internal chassis. This procedure opens the card retainer baffle.



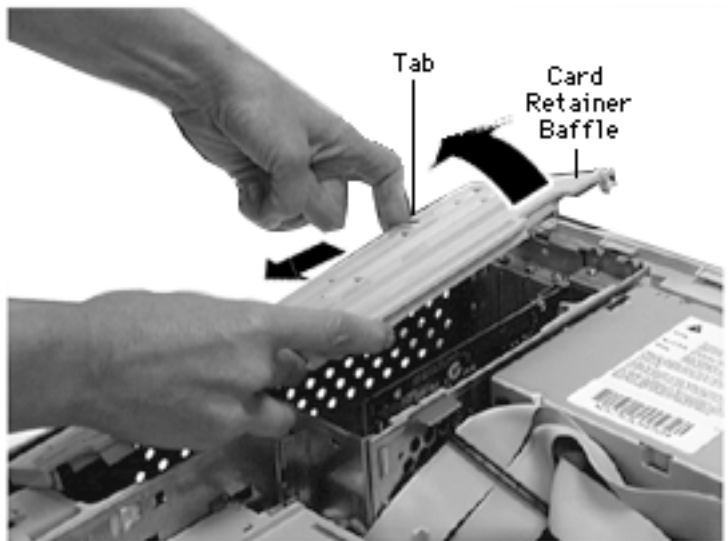

To Remove the Card Retainer Baffle:

- 2 With the baffle slightly raised, push in on the top tab to release it from the chassis frame and then pull the baffle out and away from the chassis to free the bottom tab.





Open Internal Chassis

Before you begin, open the card retainer baffle.

- 1 Release the chassis latches.

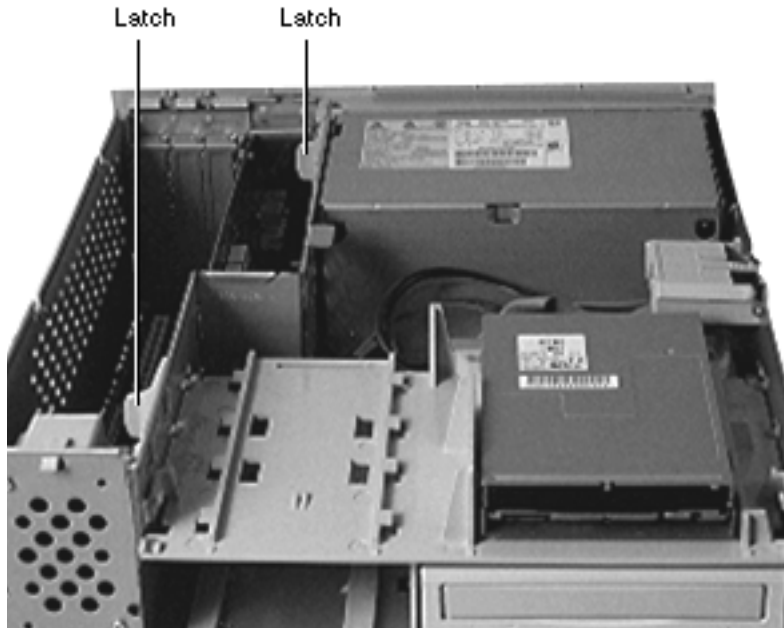



- 2 Flip out the chassis support foot.

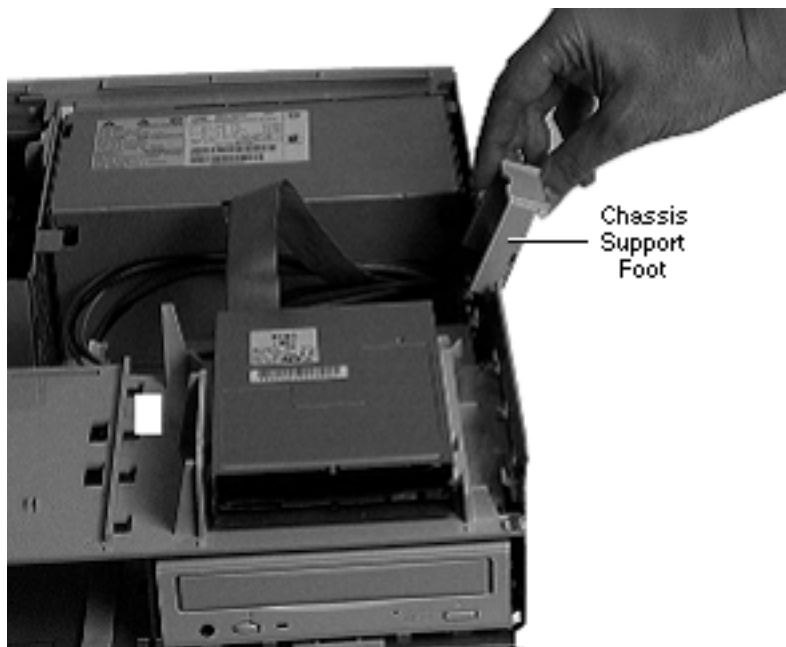

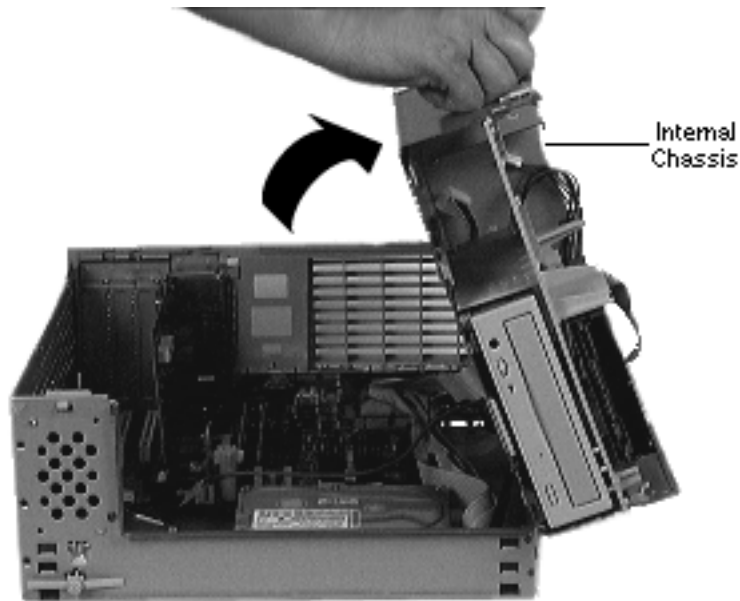

- 3 Swing open the internal chassis that contains the power supply. Be sure the internal chassis is perpendicular to the bottom chassis and fully supported by the chassis support foot.



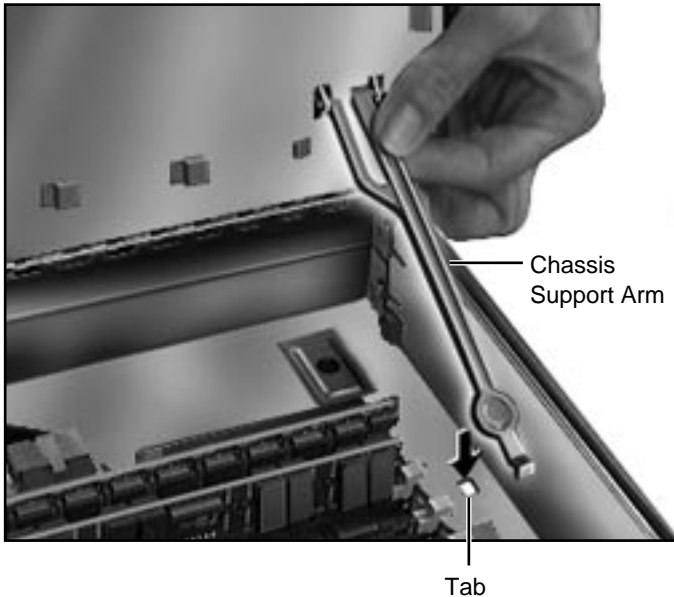

- 4 To secure the internal chassis in the up position, flip down the chassis support arm. Make sure the tab on the bottom of the support arm is securely fastened in the hole provided in the bottom chassis.

Warning: To be safe, never work on the computer with the internal chassis in the up position unless the chassis support arm is down and securely fastened.





Hard Drive

Before you begin, do the following:

- Remove top housing
- Open Card Retainer Baffle
- Open internal chassis

Note: The hard drive is in the bottom of the chassis, in front of the logic board.

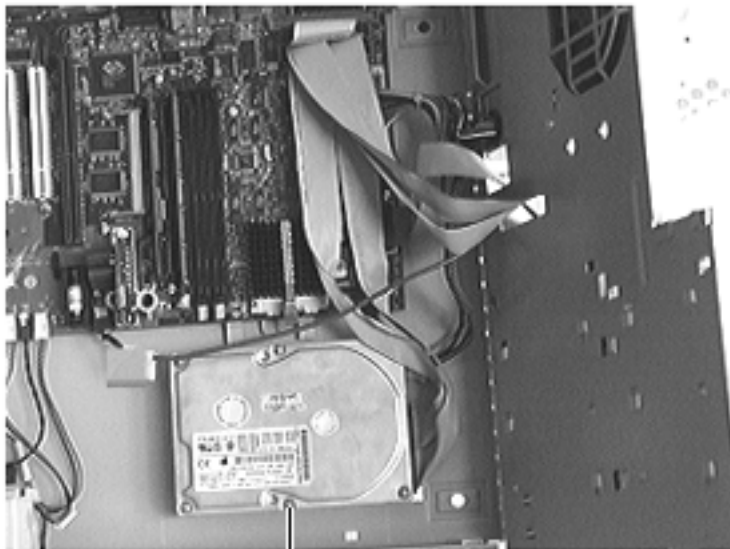

Hard Drive





- 1 Disconnect the cables from the hard drive.

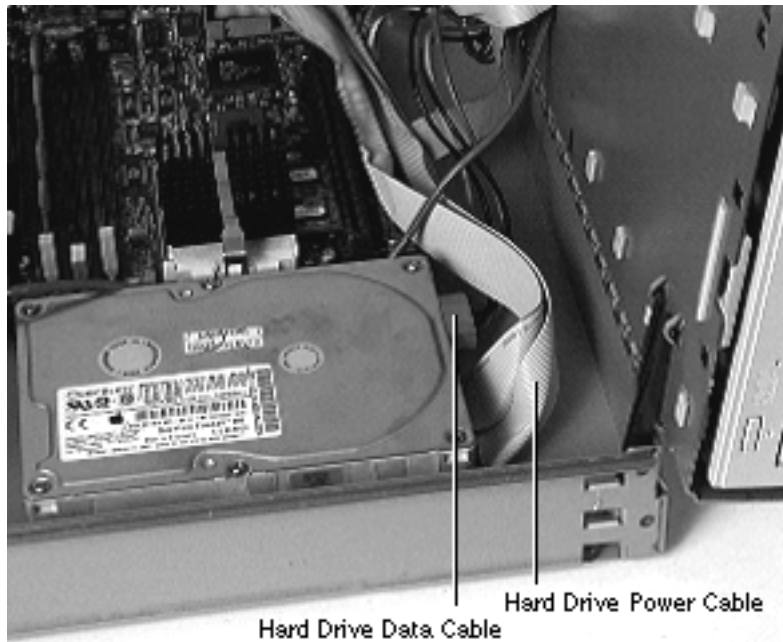



Release Tab

- 2 Pull up the release tab at the front of the hard drive and push the back of the hard drive to remove it from the drive chassis.

Note: For information on removing the hard drive from its carrier and returning drives, cables, and carriers to Apple, refer to Additional Procedures in the Hard Drives manual.





Drive Rails

Before you begin, do the following:

- Remove top housing
- Remove CD-ROM or DVD-ROM drive
- Remove Zip drive
- Open Card Retainer Baffle
- Open internal chassis
- Remove hard drive

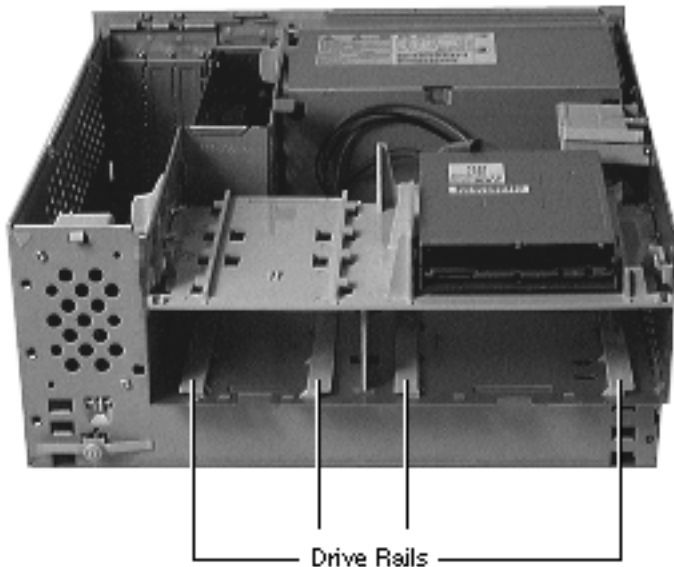

Note: The drive rails attach to the chassis underneath the CD-ROM or DVD-ROM drive, Zip drive, and hard drive.



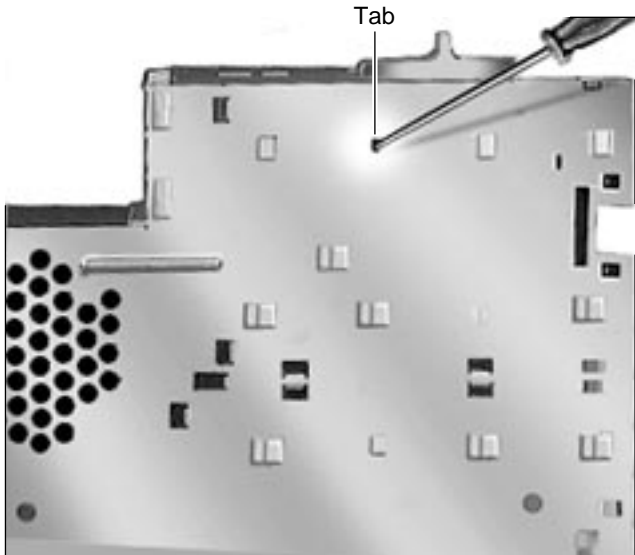

- 1 Use a screwdriver to push out the tab indicated in the illustration.
- 2 Slide the drive rail either forward or backward (depending on which way the tabs are facing) and lift it from the chassis.





Power Supply

Power Supply

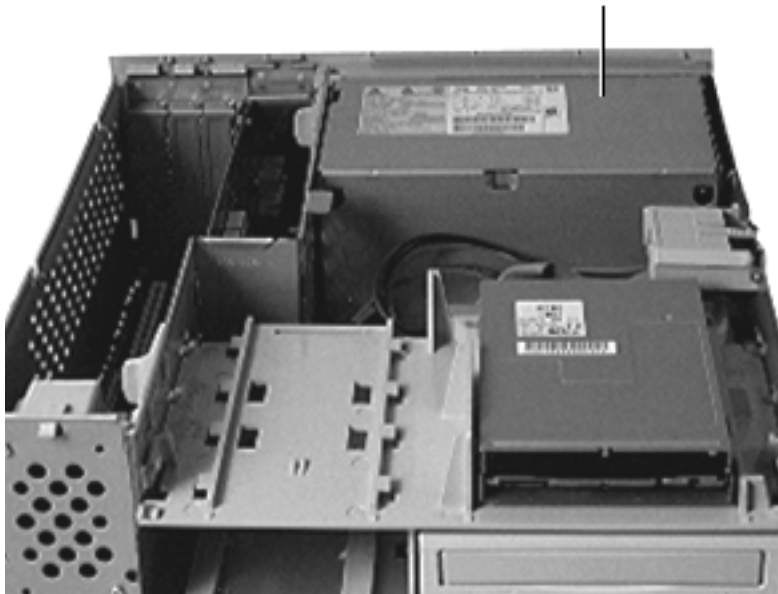

Before you begin

- Remove top housing
- Open Card Retainer Baffle
- Open internal chassis

Note: As you face the computer, the power supply is in the back right corner.

IMPORTANT: To avoid damaging the computer, be sure the voltage switch on the back of the power supply is set correctly (115V in the U.S.) when you replace the power supply.





- 1 Disconnect the power supply cable from the CD-ROM or DVD-ROM drive.
- 2 Open the internal chassis.

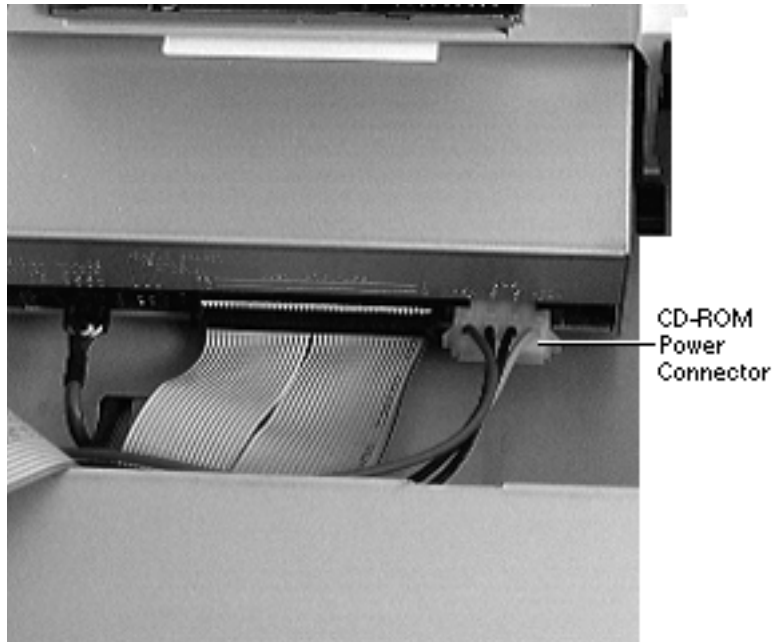



- 3 Disconnect the power supply cable from the hard drive and the logic board.

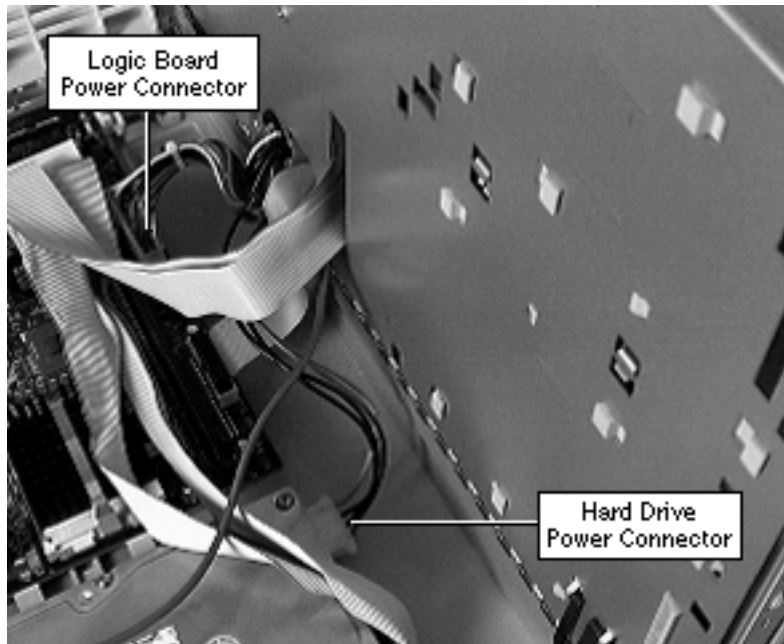

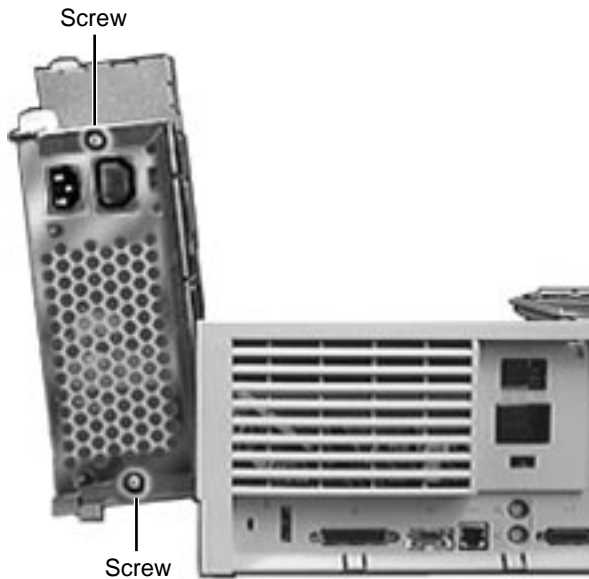

- 4 From the back of the computer, remove the two screws that secure the power supply to the chassis.



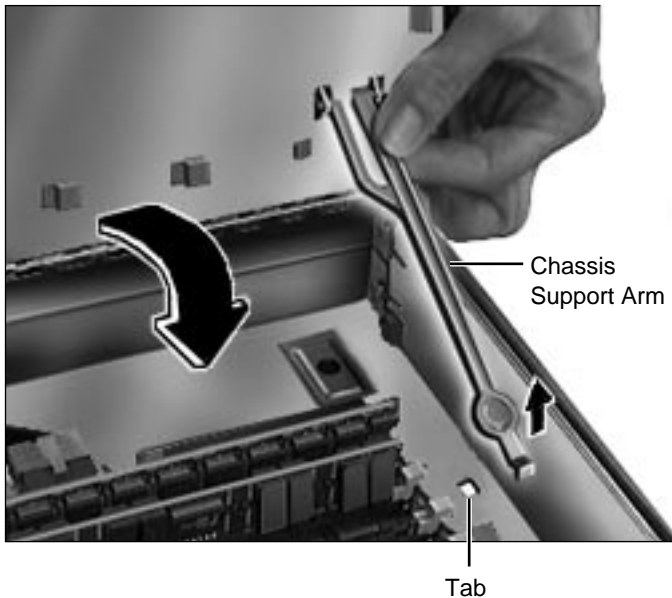

- 5 Release the chassis support arm and swing down the internal chassis.



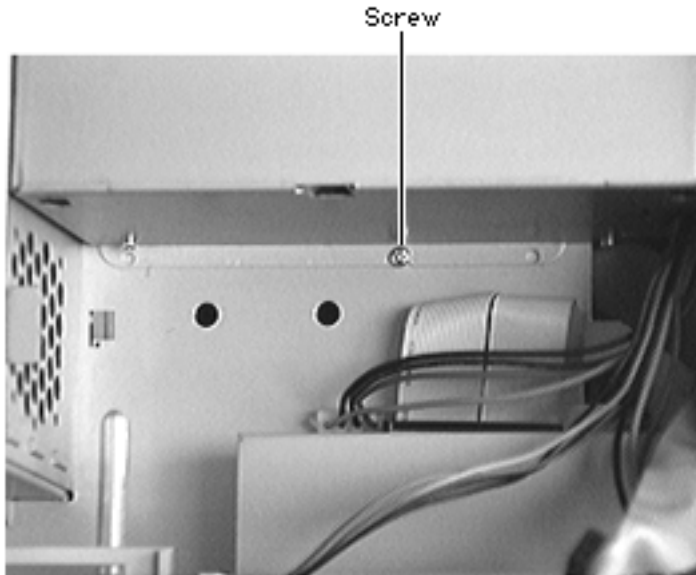

- 6 Remove the screw that secures the power supply to the bottom of the internal chassis





- 7 Slide the power supply forward and pull it out of the computer. You will need to feed the power supply cables that connect to the logic board up through the hole in the chassis.

IMPORTANT : Make sure the switch on the back of the power supply is set to the correct voltage (115V in the U.S.). (Refer to the international voltage chart in the Basics chapter under the topic “Voltage Switch” for more information.) The





switch is accessible through the computer's rear panel when the power supply is installed.

Replacement Note: There are two metal tabs on the back of the metal chassis and one metal tab on the bottom of the chassis that lock into the power supply. When replacing the power supply, slide it back until it locks into place.

Replacement Note: When the power supply module is replaced, it may or may not have an internal relay. Without the relay, the monitor connected to the computer will need to be turned on manually.





Speaker

Before you begin, remove the top housing.

Note: As you face the computer, the speaker is in the front left corner of the bottom chassis.

- 1 Swing open the internal chassis.

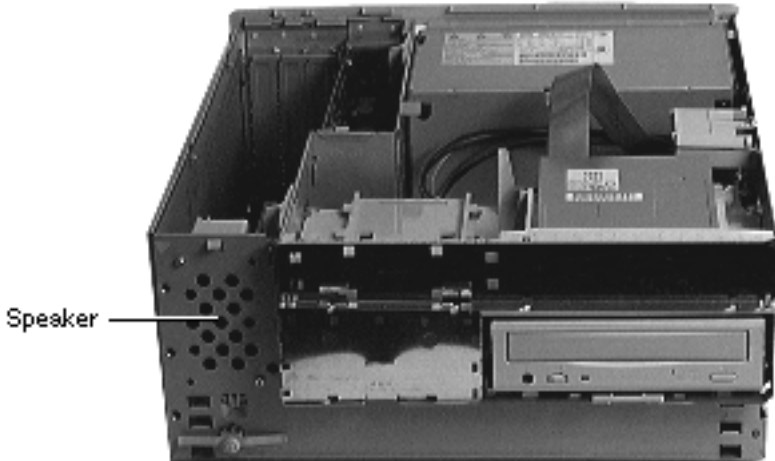



- 2 Remove the two Torx screws that secure the speaker to the metal chassis.

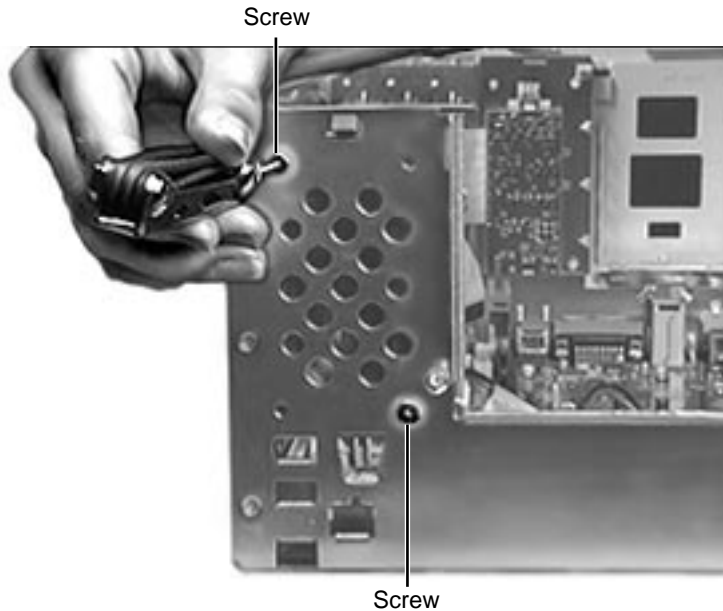

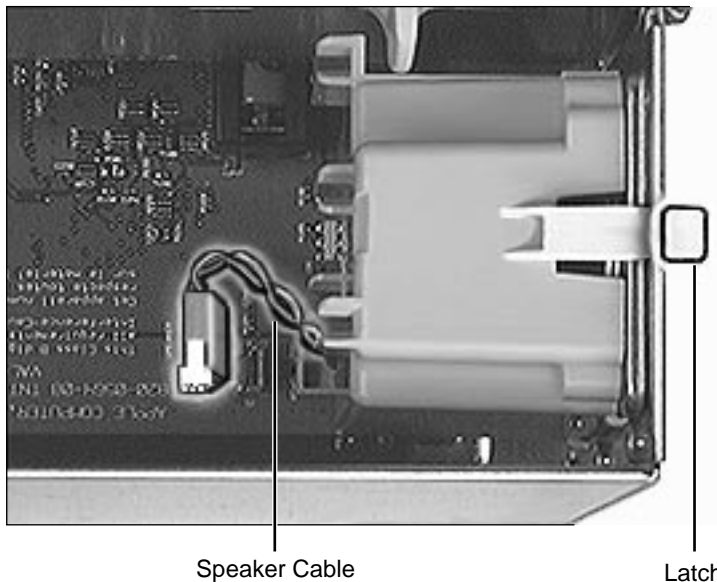

- 3 Disconnect the speaker cable from the logic board.
- 4 Press the latch holding the speaker to the chassis and lift the speaker out of the computer.





Power Actuator

Before you begin, remove the top housing.

Note: As you face the computer, the power actuator is in the front left corner of the bottom chassis (directly beneath the speaker).

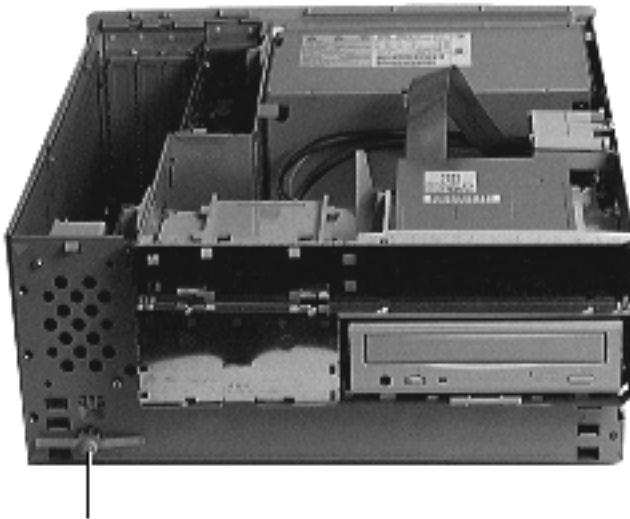

Power Actuator



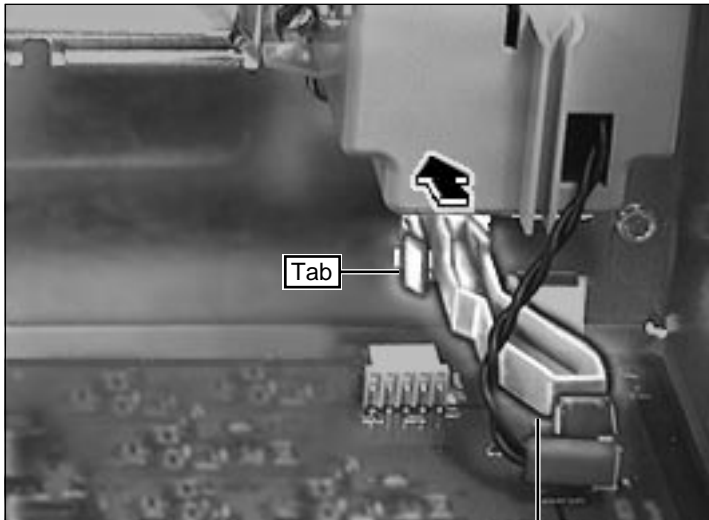

Tab

Power Actuator

- 1 Push in the tab that secures the power actuator to the chassis and push the power actuator out of the computer.





Processor Module

Before you begin, do the following:

- Remove top housing
- Open Card Retainer Baffle
- Open internal chassis

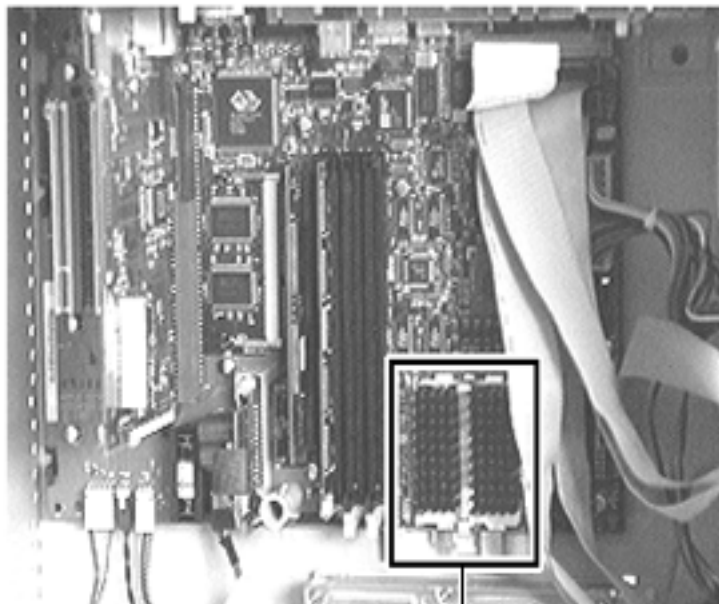

Processor w/Heatsink



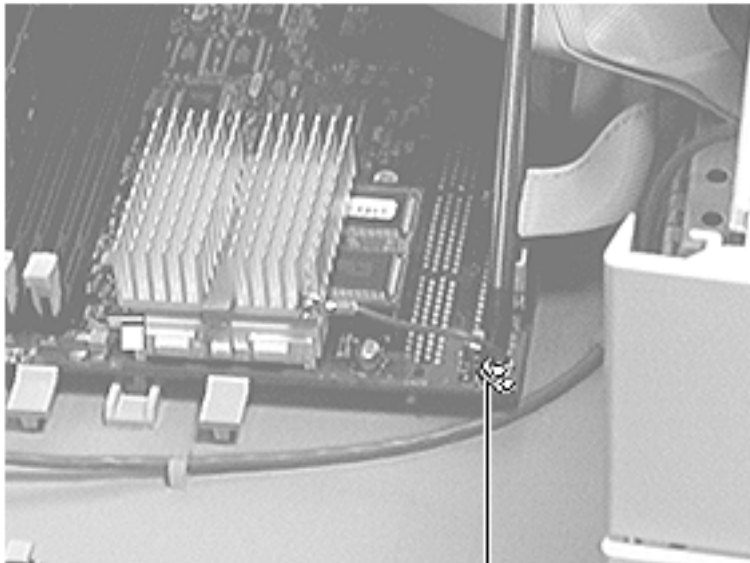

Screw

- 1 Remove the screw that holds the processor module wire to the logic board.

Replacement Note: The processor module wire attaches to the top of the logic board (not underneath). When screwing down the wire, be careful not to damage the capacitor that is next to the screw hole. Use a manual screw driver to avoid damaging the capacitor.



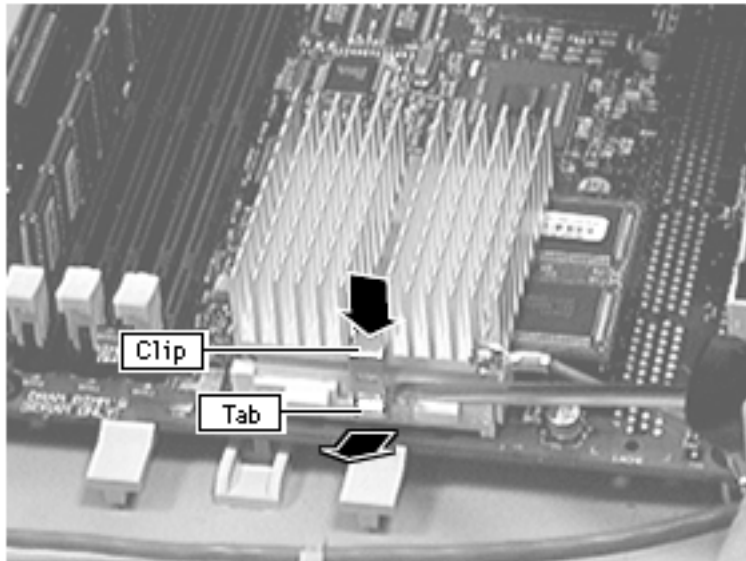

Warning: The heat sink may be hot to the touch.

- 2 While pressing down on the top of the clip that secures the heatsink, use a small flatblade screwdriver to lift up on the front tab of the clip to release it.



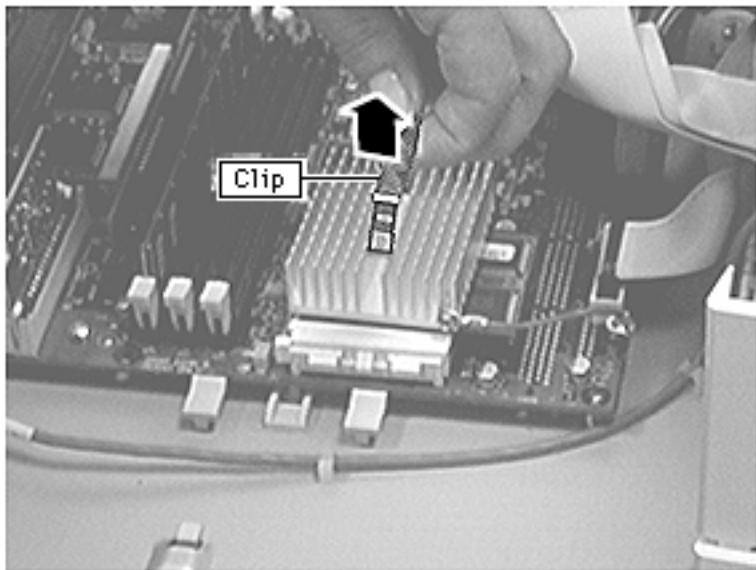

- 3 Lift up the clip and remove it from heatsink.



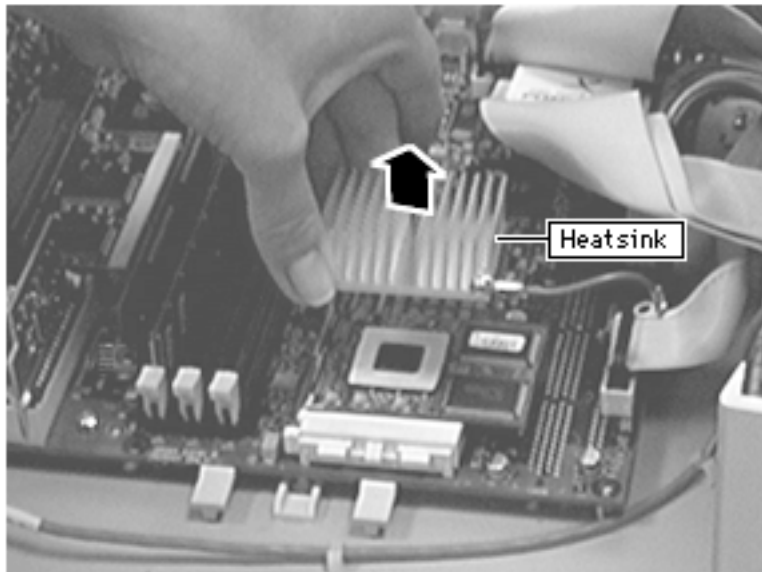

- 4 Lift up the heatsink to remove it from the processor module.



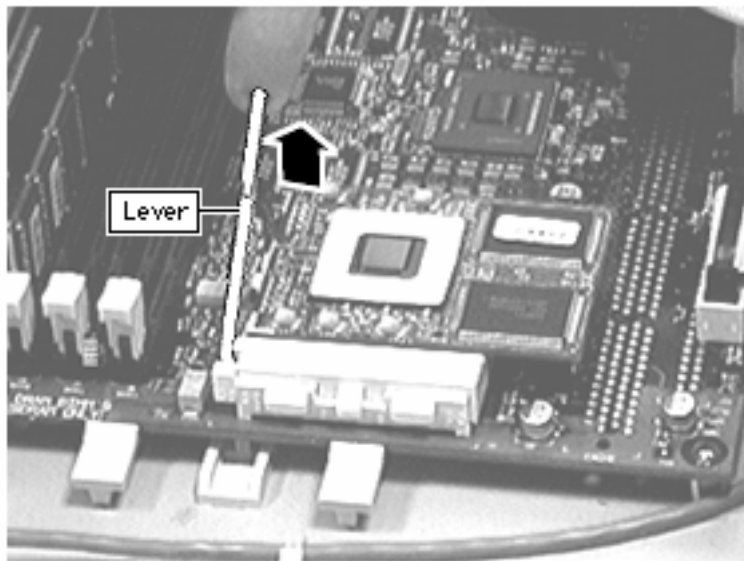

- 5 Lift the metal lever at the left of the processor module.





Processor Module

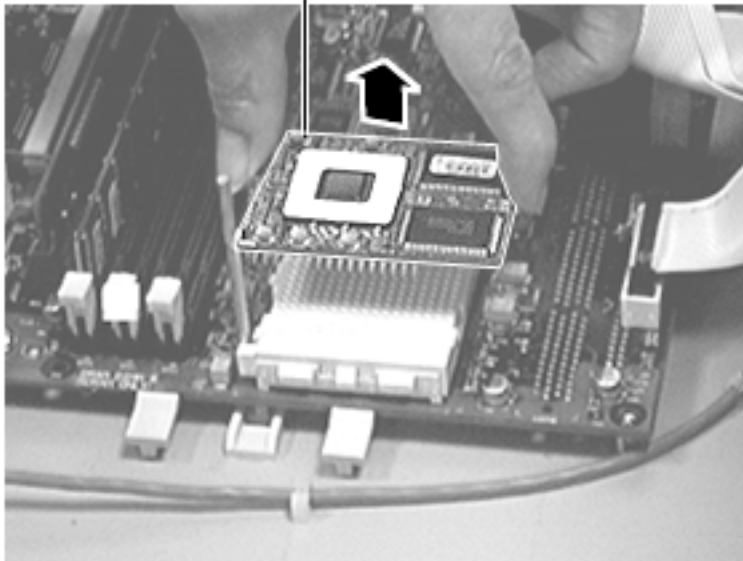

- 6 Pick up the processor module by the edges and gently lift straight up to remove it. Be careful not to bend the pins underneath the module.

IMPORTANT: If you are only replacing the processor module, stop here. If, however, you are removing the processor module in order to replace the logic board, continue on to the next page.

Replacement Note: Don't force the processor module.

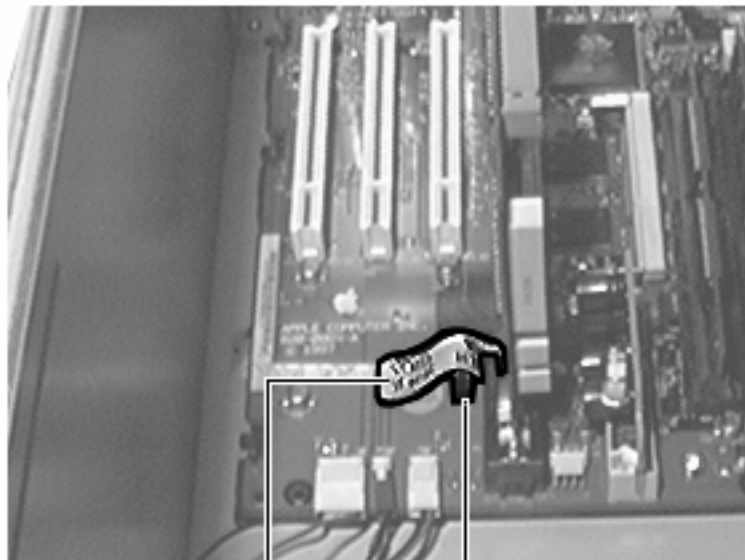

Warranty
StickerJumper
Block

- 7 Remove the warranty sticker and red jumper block located next to the battery if replacing the logic board only.

IMPORTANT: When replacing the processor module, you must change the processor jumper block and warranty sticker to be compatible with the processor module you are installing. Failure to install the jumper block properly will result in a unit that does not power on. See the instructions on the following page.



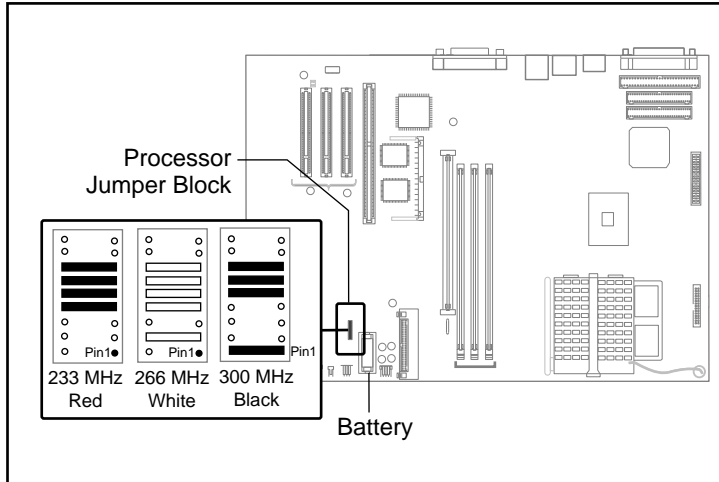

- 8 Install the jumper as shown. Depending on the computer's processor speed, you will install a red jumper (233 MHz), a white jumper (266 MHz), or a black jumper (300 MHz). Be sure to cover the pins as shown and to install the jumper block with the gold connector pins facing down towards the board.

Replacement Note: Position the processor module over the slot, seat it evenly, and press down gently on the



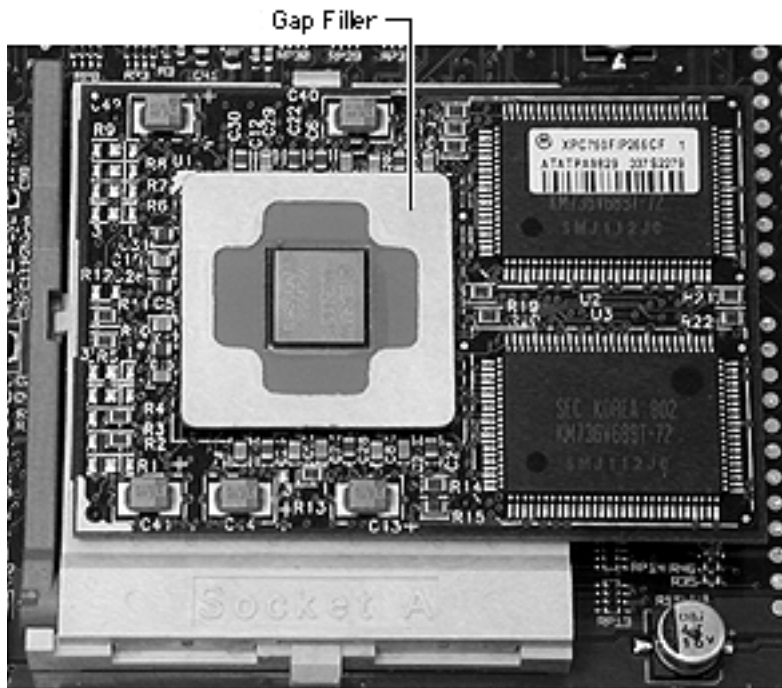

module to install it. Never force the module or you may damage the gold connector pins on the underside. Flip down the metal lever that secures the module.

Install a gap filler, 922-3643, on a new processor.

Replace the heatsink, insert the clip onto the tab at the rear of the module, swing the clip over the heatsink, and secure the front latch.





Battery

Before you begin, do the following:

- Remove top housing
- Open Card Retainer Baffle
- Open internal chassis

Note: As you face the computer, the battery is near the front left corner of the logic board.

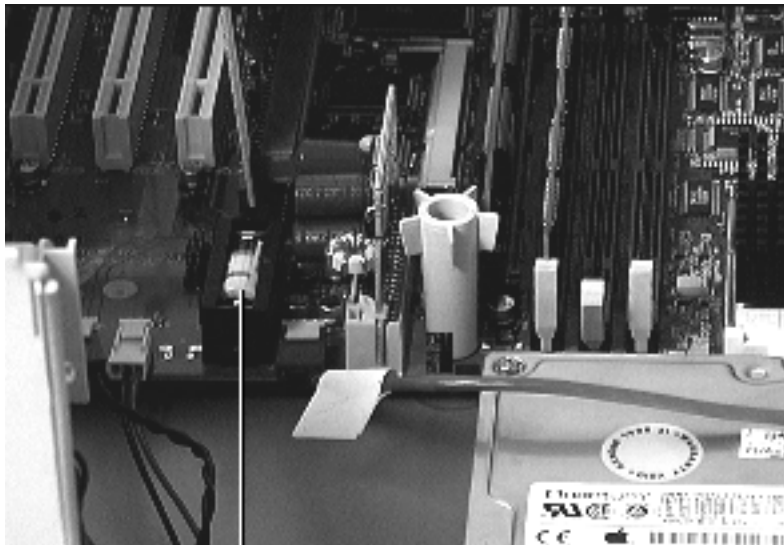

Battery





- 1 Use a screwdriver to gently pry up one side of the battery cover.

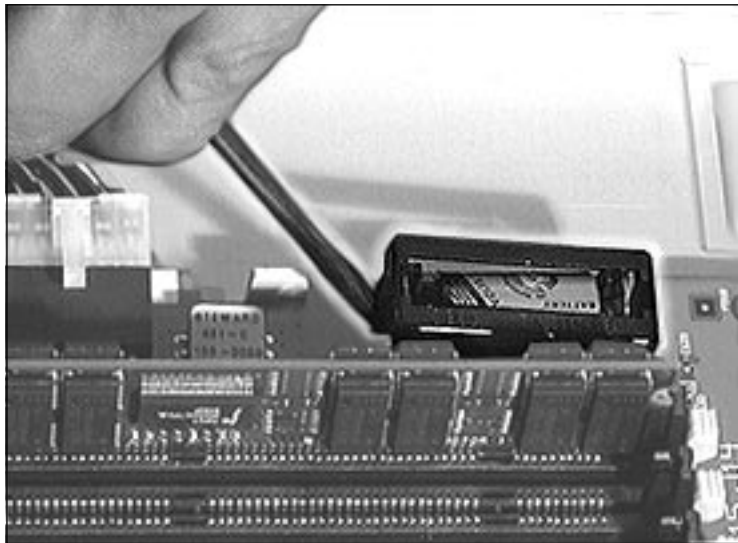

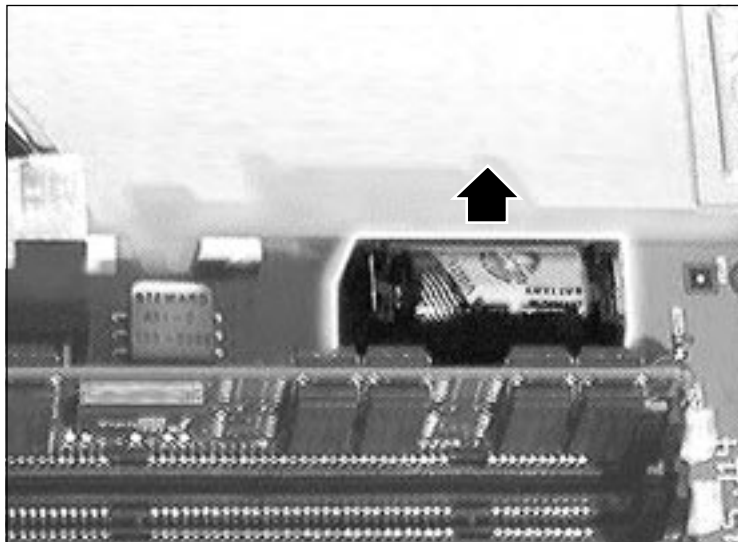

- 2 Lift up the battery to remove it from the logic board.



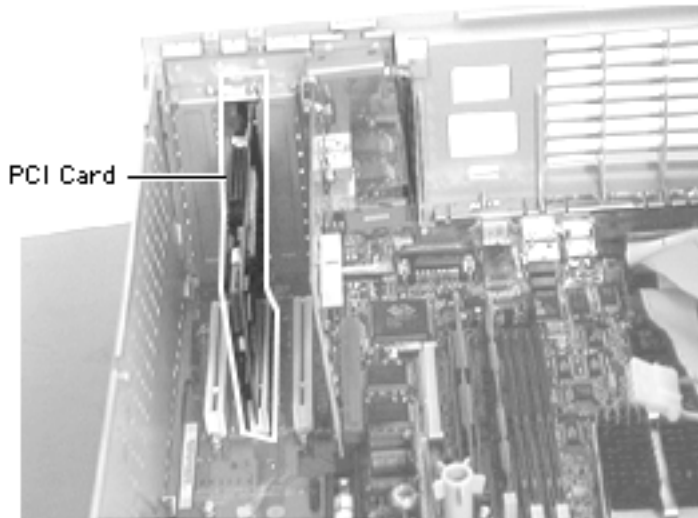

PCI Cards

Before you begin, do the following:

- Remove top housing
- Open Card Retainer Baffle
- Open internal chassis

Note: PCI expansion cards, if present, install perpendicularly to the logic board (and directly behind the I/O audio card) in one of three PCI slots.

Note: Take-apart for Ultra Wide and FireWire PCI cards follows this topic.



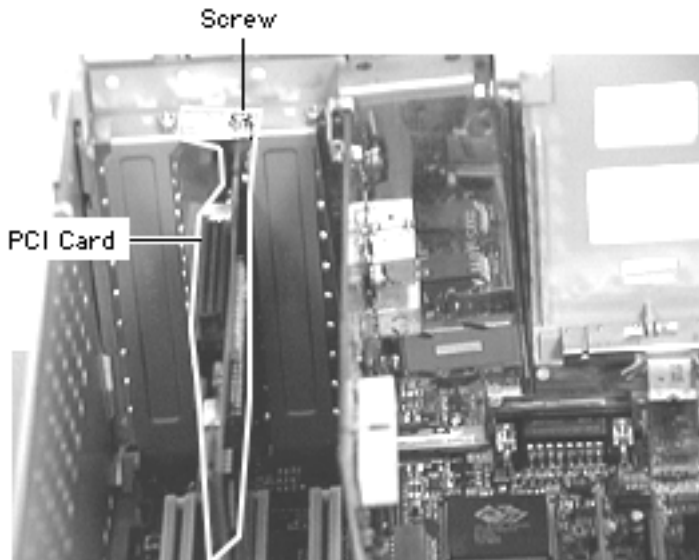

- 1 Remove the screw that secures the PCI card to the back of the chassis.



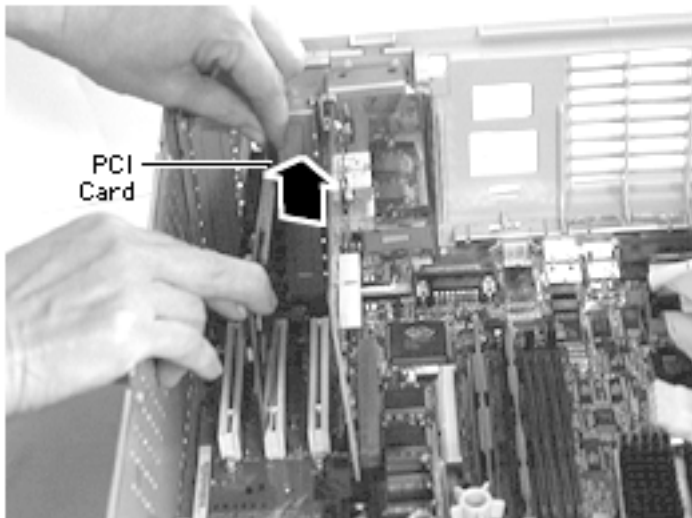

- 2 Grab the corners of the PCI card and pull up the card to remove it.





Ultra Wide SCSI PCI Card

The ultra wide SCSI card installs like any other PCI card (see the PCI Cards take-apart topic for more information); however, the ultra wide SCSI card must be installed in the first PCI slot (that is, the PCI slot nearest the video card). In addition, the ultra wide SCSI cable must be routed in a very specific manner. The procedure for installing and routing the ultra wide SCSI cable is explained on the following pages.





Ultra Wide SCSI Cable

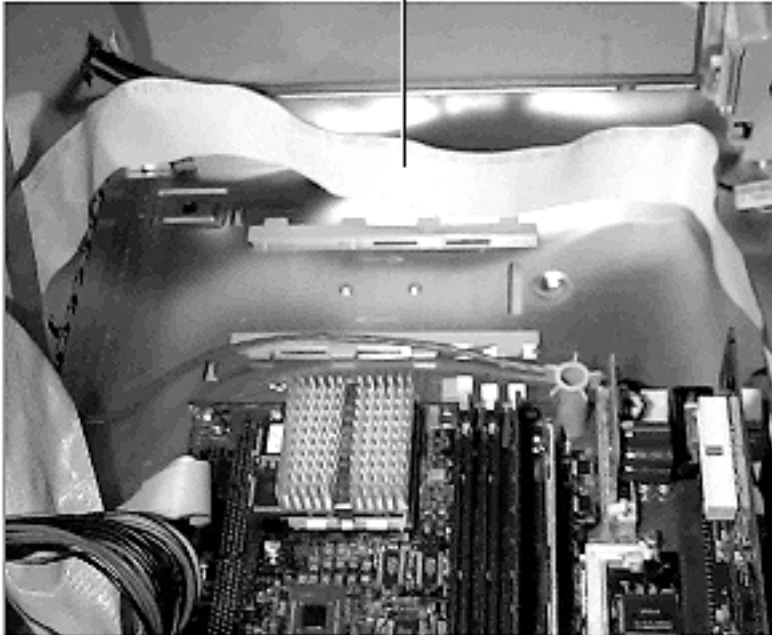

- 1 Attach the end of the ultra wide SCSI cable that has just one connector to the ultra wide SCSI PCI card.
- 2 Route the cable along the back edge of the chassis and away from the logic board. If there is an additional hard drive installed in the bottom chassis, the cable will run between the hard drive and the back chassis wall.





SCSI
Cable

Power
Cable

IDE
Cable

Ultra Wide
SCSI Cable

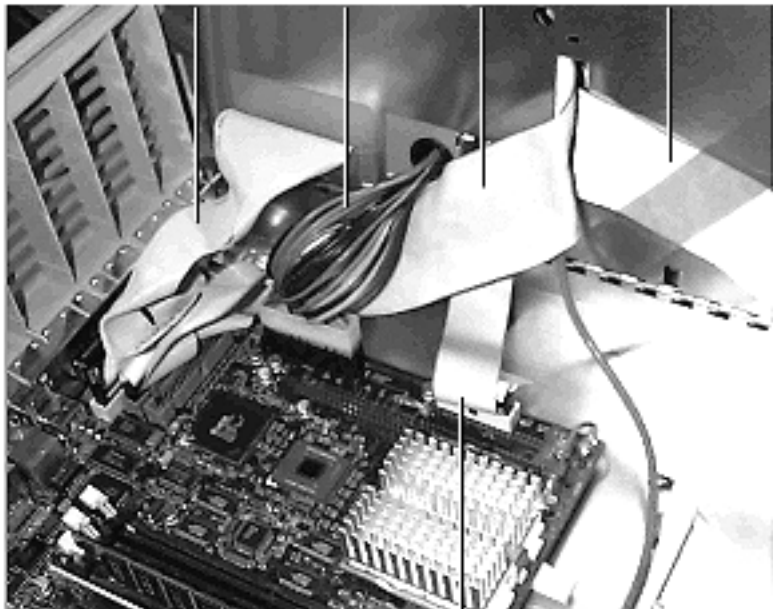

Floppy Drive Cable

- 3 Feed the ultra wide SCSI cable through the first cut out in the drive chassis.





Ultra Wide Primary Connector



Second Ultra Wide Connector

- 4 Attach the very end of the cable that has two connectors to the upper (maybe only) ultra wide hard drive. If a second ultra wide hard drive is installed in the lower bay, connect the second to last ultra wide SCSI cable connector to this lower drive.





Ultra Wide SCSI Cable 50-Pin SCSI Cable Power Supply



Floppy Drive Cable

- 5 Route the ultra wide SCSI cable on top of the 50-pin SCSI cable and tape them both to the power supply. The ultra wide SCSI cable must be away from the CD-ROM drive, and the floppy cable should be routed on top of the other cables.

Note : Be sure to use the Kapton tape that is on the service price list to secure the cables.





Leaf Gasket

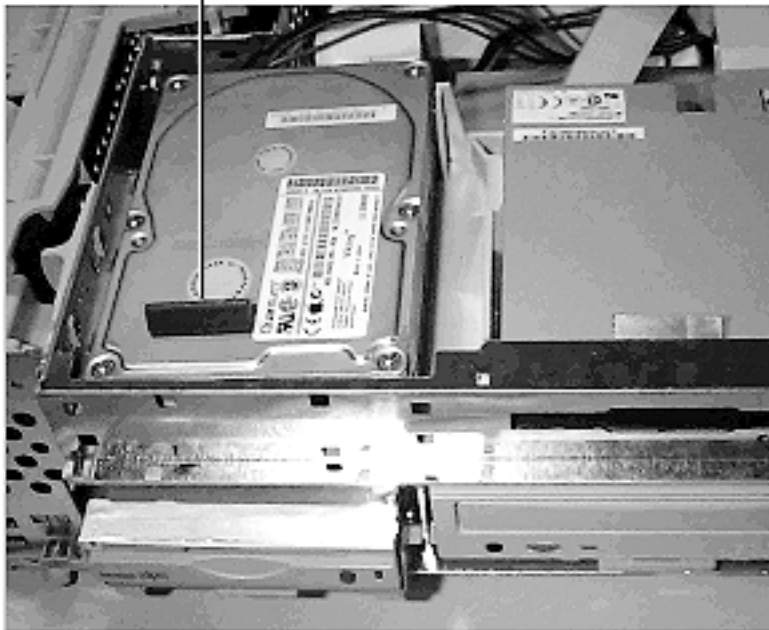

Note: You must order leaf gaskets to install on the ultra wide hard drive whenever you replace this module.

- 6 If the ultra wide hard drive is installed in the upper bay, place one leaf gasket on the top front end of the hard drive (as shown here) and place another leaf gasket on the right side of the CD-ROM or DVD-ROM drive so that it makes contact with the drive and the internal chassis.





FireWire PCI Card

Before you begin, do the following:

- Remove top housing
- Open Card Retainer Baffle
- Open internal chassis

Note: The FireWire card comes from the factory installed in the middle PCI slot.

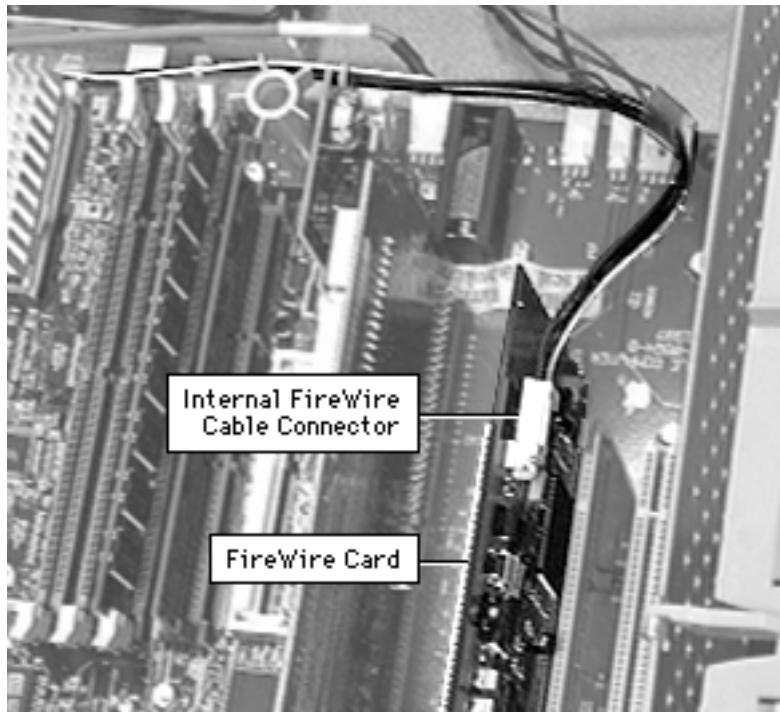

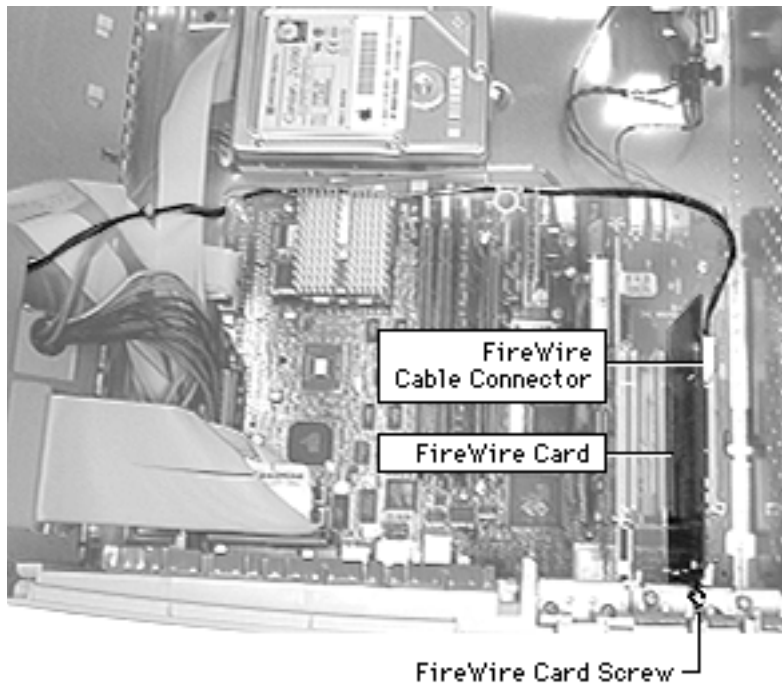

- 1 Disconnect the internal FireWire cable from the card.
- 2 Using a Phillips screwdriver, remove the screw securing the FireWire card to the rear panel and gently lift up on the card to remove it.



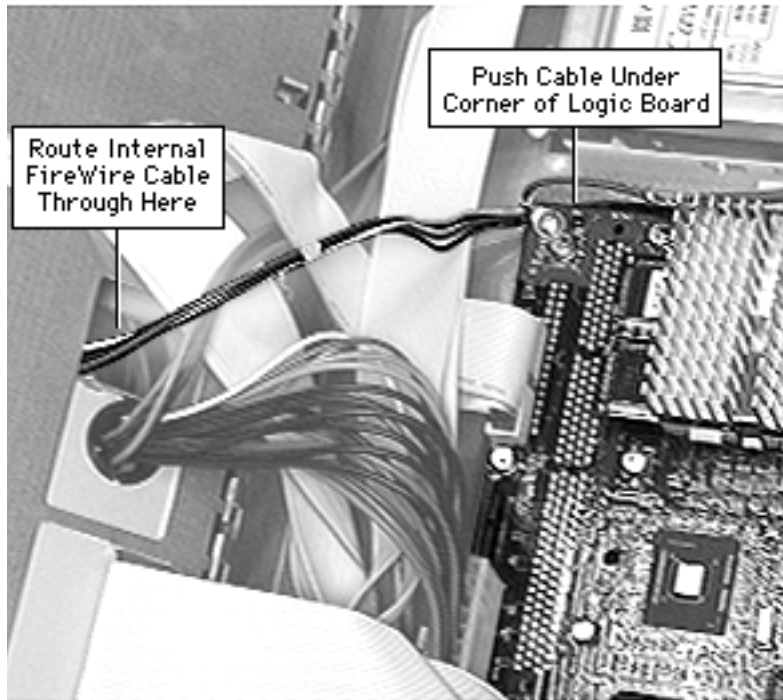

Replacement Note : The following steps explain how to route and reconnect the FireWire cable.

- 3 After connecting the internal FireWire cable to the card, route the cable along the edge of the logic board. Tuck the cable underneath the corner of the logic board to keep it out of the way.
- 4 Run the internal FireWire cable through the opening in the drive chassis as shown.



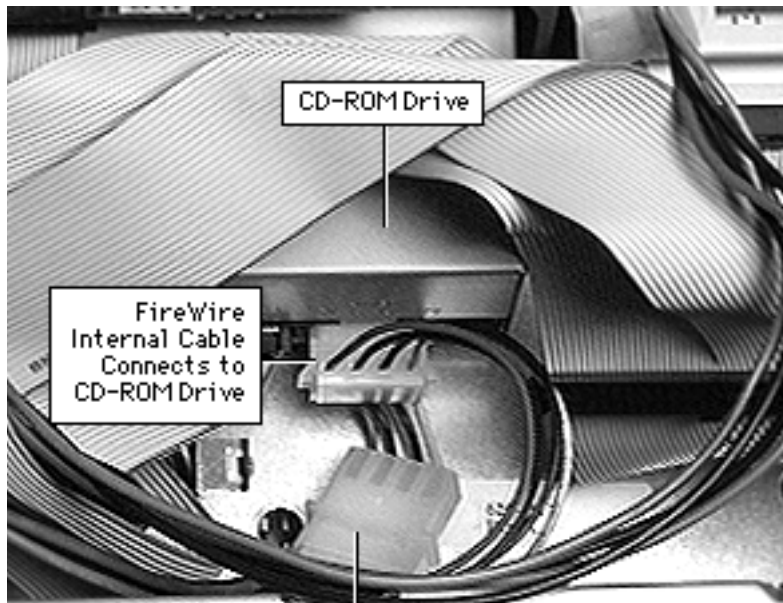

CD-ROM Drive

FireWire Internal Cable Connects to CD-ROM Drive

FireWire Internal Cable Connects to Power Supply Cable

- 5 Run the FireWire cable up to meet the drives. Then, connect the very end of the FireWire cable to the power supply cable.
- 6 Connect the second to last connector on the FireWire cable to the back of the CD-ROM or DVD-ROM drive.



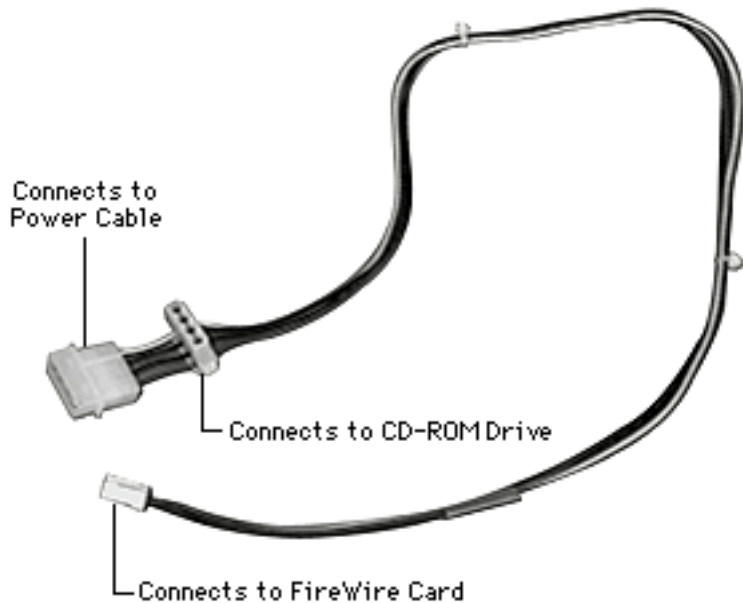

Note: The graphic at left shows the internal FireWire cable and each of its connectors.





I/O Card

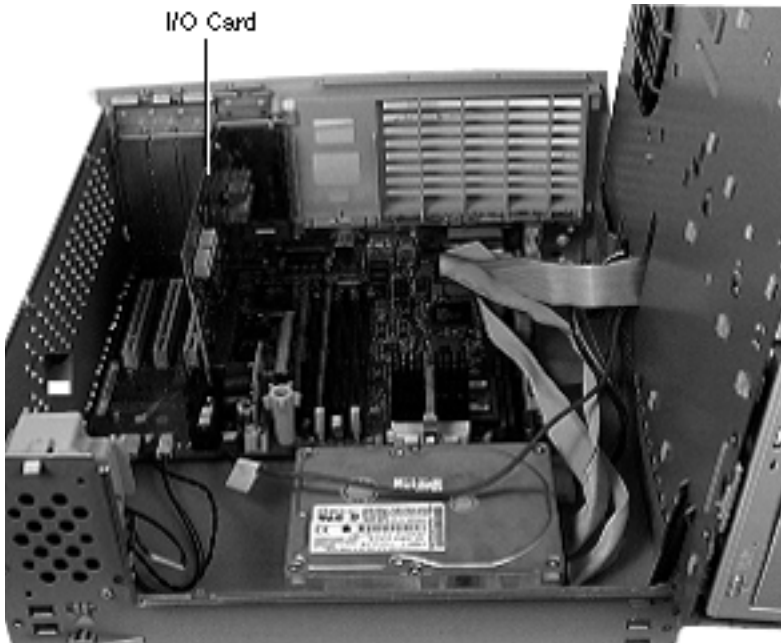

I/O Card

Before you begin, do the following:

- Remove top housing
- Open internal chassis

Note: The I/O card installs perpendicularly to the logic board. It's located under the expansion card cover next to the PCI expansion slots.

- 1 From the back side of the computer, remove the single screw that attaches the I/O card to the rear panel.



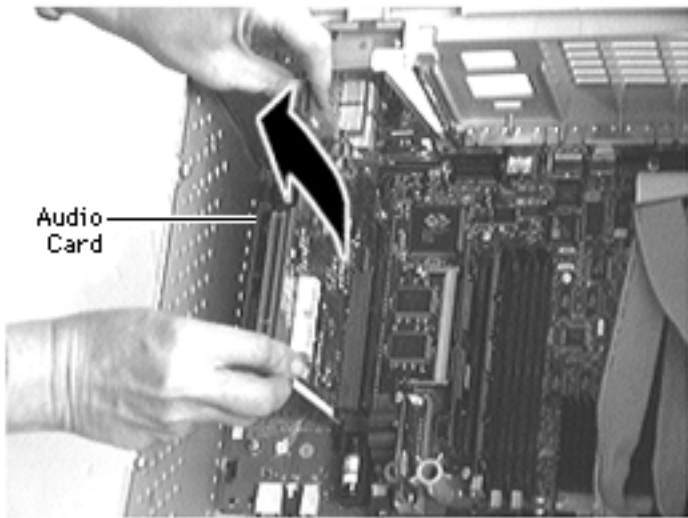

- 2 Remove the two screws that secure the I/O card to the metal chassis.
- 3 Grab the corners of the I/O card and pull up the card to remove it.





Logic Board

Before you begin, do the following:

- Remove top housing
- Open Card Retainer Baffle
- Open internal chassis
- Remove PCI cards (if present)
- Remove I/O card
- Remove processor module (only if you are replacing the logic board)

Note: The logic board is located in the very bottom of the bottom chassis.

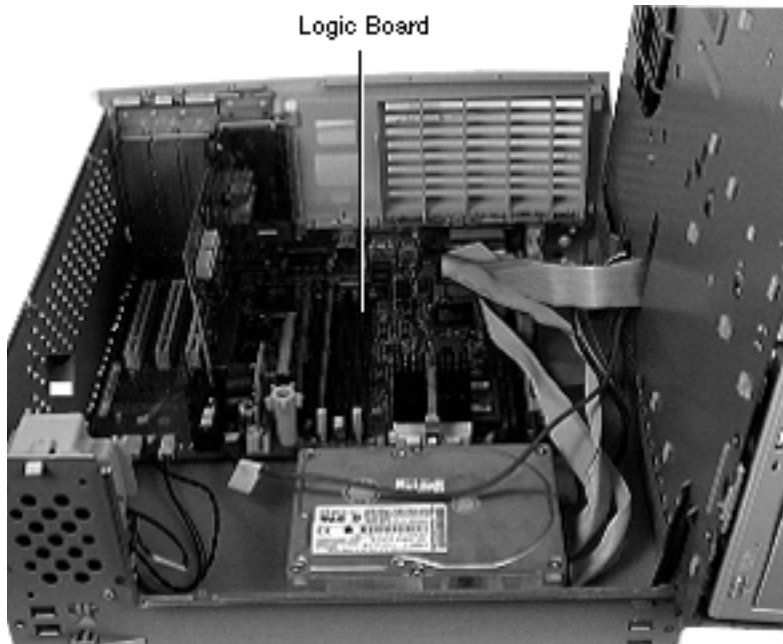

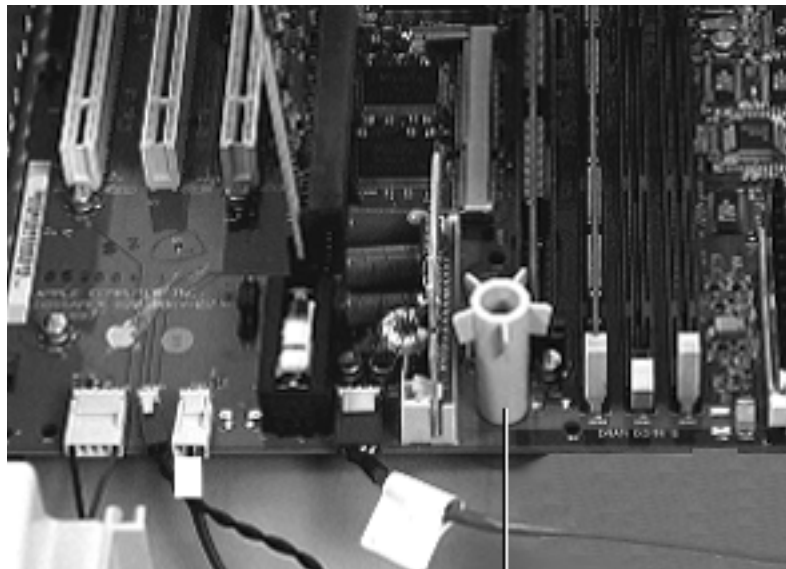

Top Column Support

- 1 Swing open the expansion card cover to provide access to the logic board.
- 2 Disconnect all cables from the logic board.
- 3 Remove the screw inside the top column support that secures the logic board to the chassis.



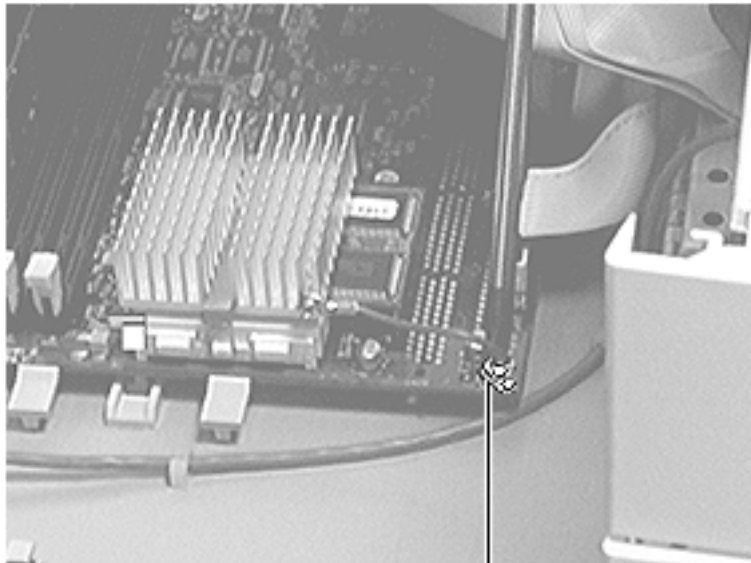

Screw

- 4 Remove the screw that attaches the processor module wire to the logic board.

Replacement Note: The processor module wire attaches to the top of the logic board (**not** underneath). Be careful not to damage the nearby capacitor when screwing down the processor wire.



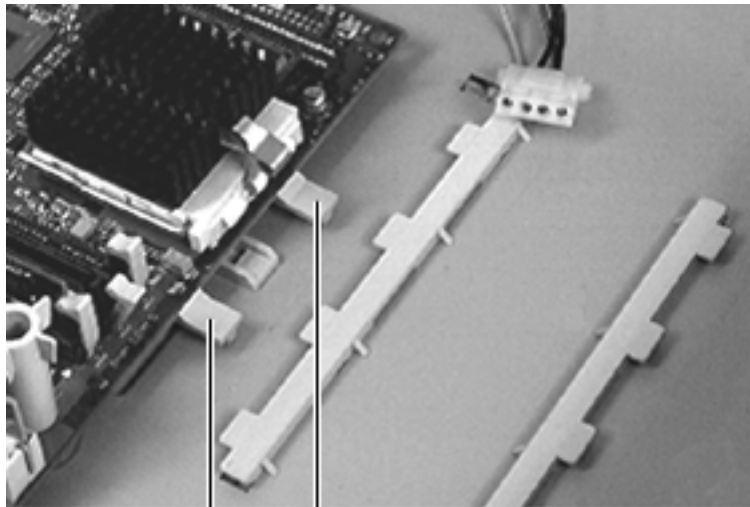

Logic Board Tabs

- 5 Press down on the two tabs at the front of the logic board and slide the board forward (away from the rear panel) to release it from the tabs. Lift the logic board from the chassis to remove it.

IMPORTANT: There is a power supply jumper on the logic board at J28 (near the PCI slots). If the logic board is installed in the PM G3 Minitower, this jumper must cover the pins marked "PS". If the logic board is installed in the PM G3





Desktop model, this jumper must cover the pins marked “Mac”. Failure to install this jumper correctly will result in a computer that will not boot up.

Note: Replacement logic boards come with the J28 jumper pre-installed in the PM G3 Desktop configuration; that is, the jumper comes installed on the “Mac” pins. If you are installing the logic board in a Power Mac G3 Minitower or Server G3 unit, you must move the J28 jumper to cover the “PS” pins. When replacing the logic board, be sure to check the power supply jumper setting.

IMPORTANT: If you are replacing the logic board, you must transfer the processor module and processor jumper (at J16) from the original logic board to the replacement board. See the take-apart instructions for the “Processor Module” for more information. You must also cover the processor jumper with a new warranty sticker, which comes with the





replacement logic board. This sticker must be in place to protect the customer's product warranty.

IMPORTANT: If you are replacing the logic board and the new logic board does not come with a voltage regulator, you must transfer the voltage regulator from the old logic board to the new board.

Note: Before returning the logic board to Apple, remove the processor module, processor jumper and warranty sticker, DRAM, SGRAM, the I/O card, and any PCI cards (if present). Do NOT remove the voltage regulator or ROM DIMM.

Replacement Note: As a final step you must reconnect all cables to the logic board. See the graphic on the following page for more information.



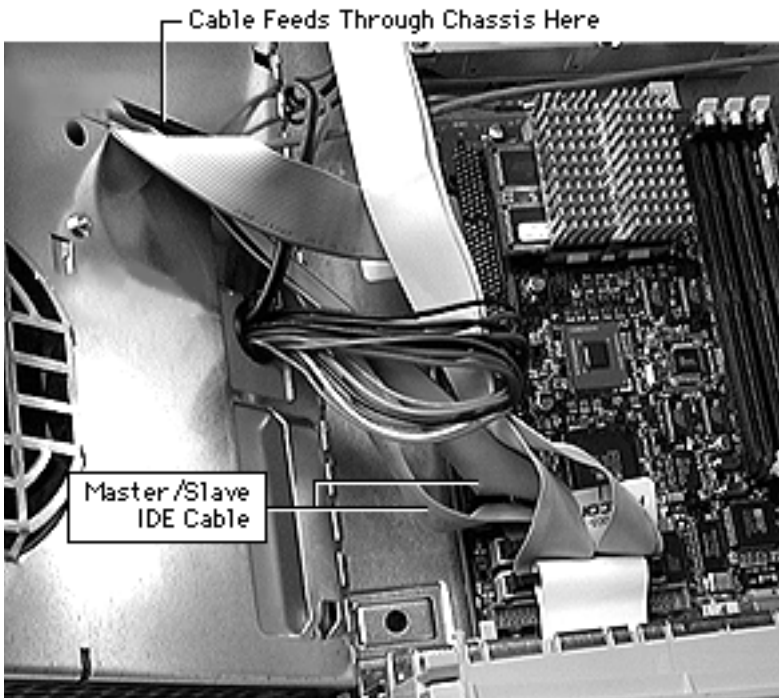

The graphic at left shows how the split master/slave IDE cable connects to the logic board. The same connector is used for both the regular IDE cable and the master/slave IDE cable that connect to the CD-ROM and Zip drives, depending on which one comes with the unit.



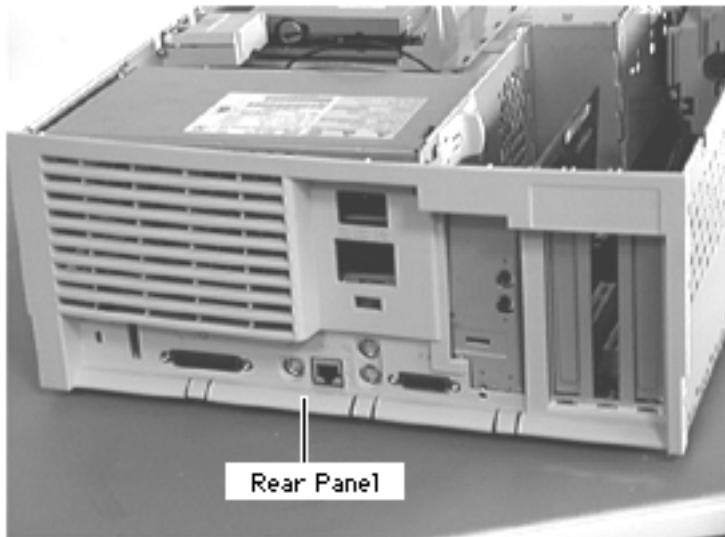

Rear Panel

Before you begin, do the following:

- Remove top housing
- Open Card Retainer Baffle
- Open internal chassis
- Remove I/O card
- Remove PCI cards (if present)
- Remove logic board (only to replace rear panel)

Note: The rear panel covers the back side of the computer and provides access to all the external connectors.



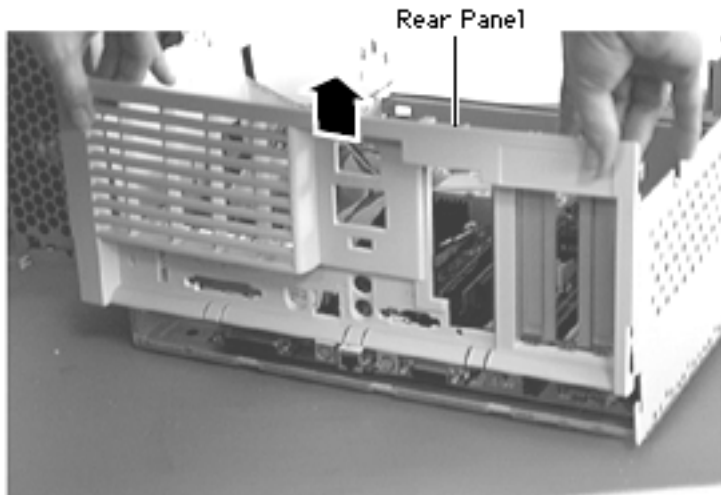

- 1 Lift the rear panel straight up to unhook it from the metal chassis. Once the rear panel is unhooked, you can remove it from the computer.

Note : There are tabs on the rear panel that hook into the metal chassis.

Replacement Note: To replace the rear panel, you must first follow the procedures for removing the logic board. Instead of fully removing the logic board





from the chassis, however, just slide it forward about an inch. Once you have the rear panel in place, slide the logic board back toward the rear panel until the board locks into place. Be sure the logic board connectors are lined up properly with the openings in the rear panel.





Bottom Chassis

Before you begin, do the following:

- Remove the top housing
- Open Card Retainer Baffle
- Remove PCI cards if present
- Remove I/O card
- Remove speaker
- Remove power supply
- Remove power actuator
- Remove all drives
- Remove chassis latches
- Remove drive rails
- Remove logic board
- Remove rear panel

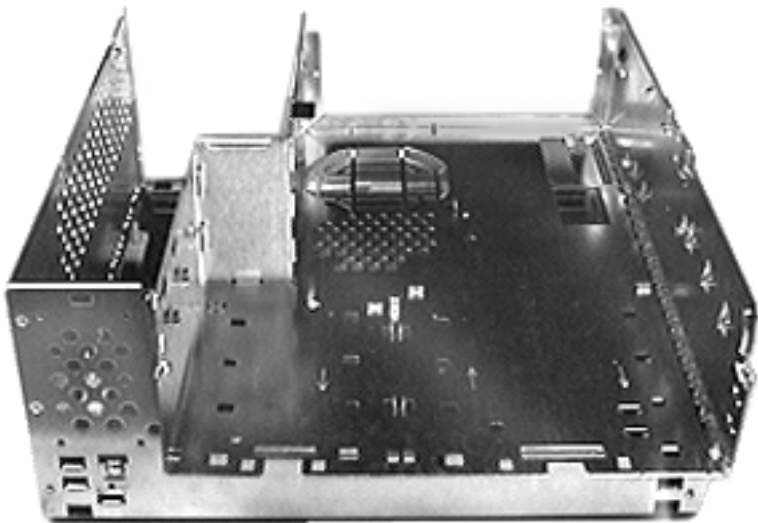



Note: The bottom chassis is what is left once all other modules have been removed.

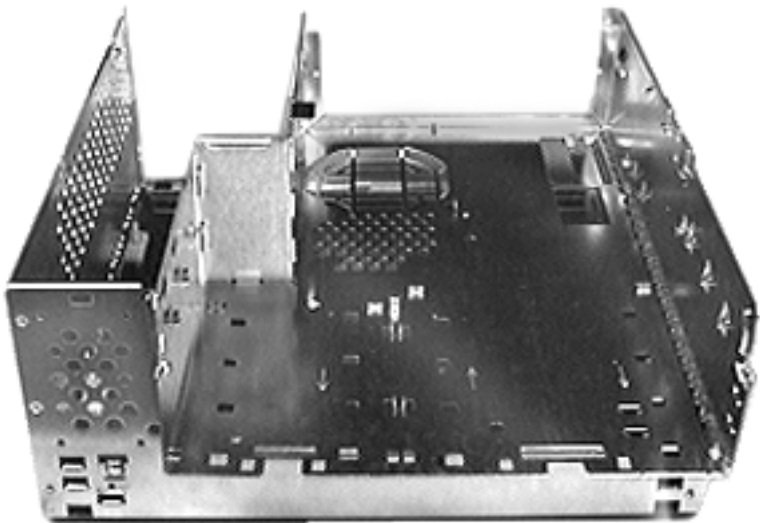



Modem Card

Before you begin, do the following:

- Remove the top housing
- Open the internal chassis
- Remove the I/O Card

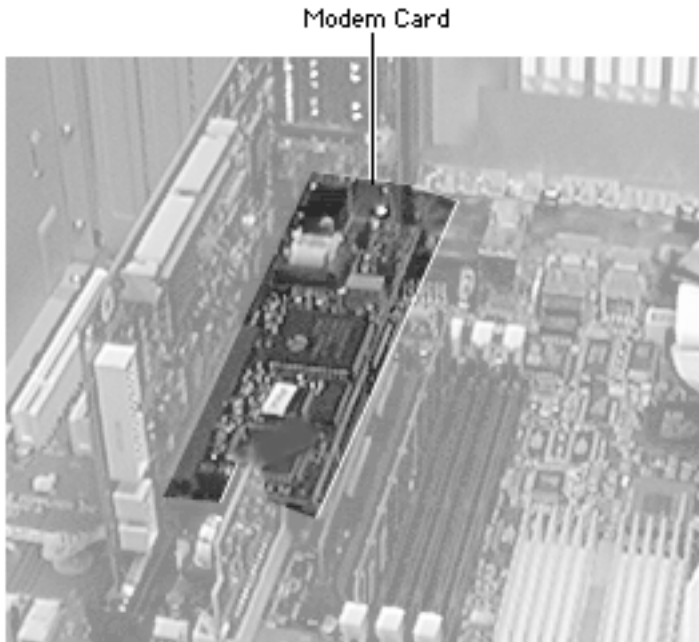

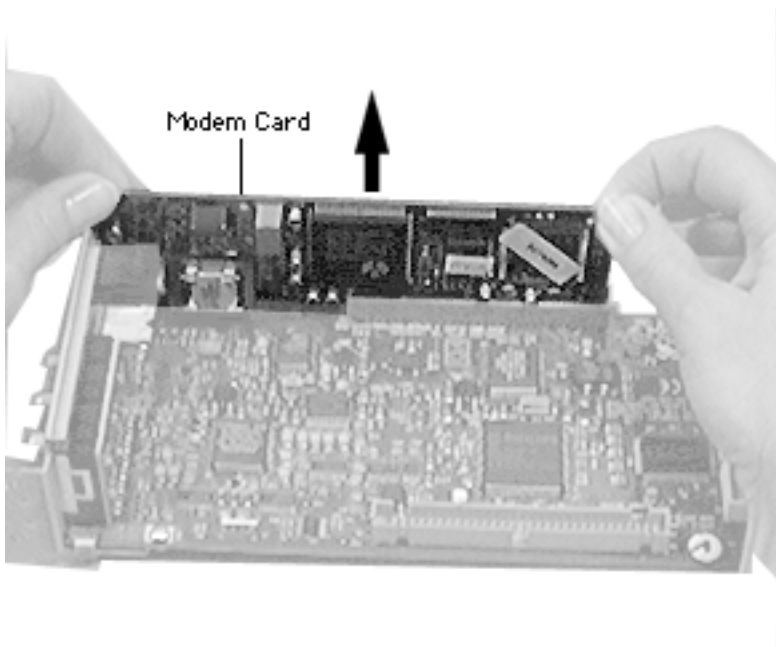

- 1 Lay the I/O card on a flat surface and gently lift up on the modem card to remove it.

Replacement Note: Align the modem card evenly over the modem slot on the I/O card and press down gently to install the card. Do not force the modem card into the slot.





Upgrades

Power Macintosh G3 Desktop





PCI or I/O Cards

Before you begin, remove the top housing.

- 1 Open the expansion card cover.

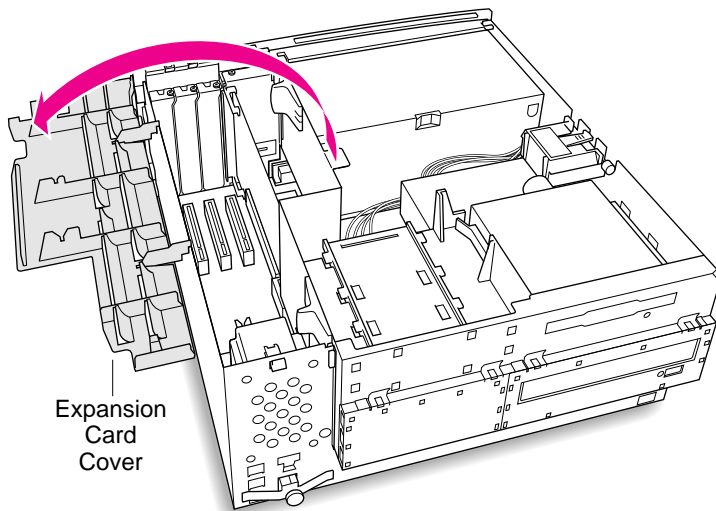

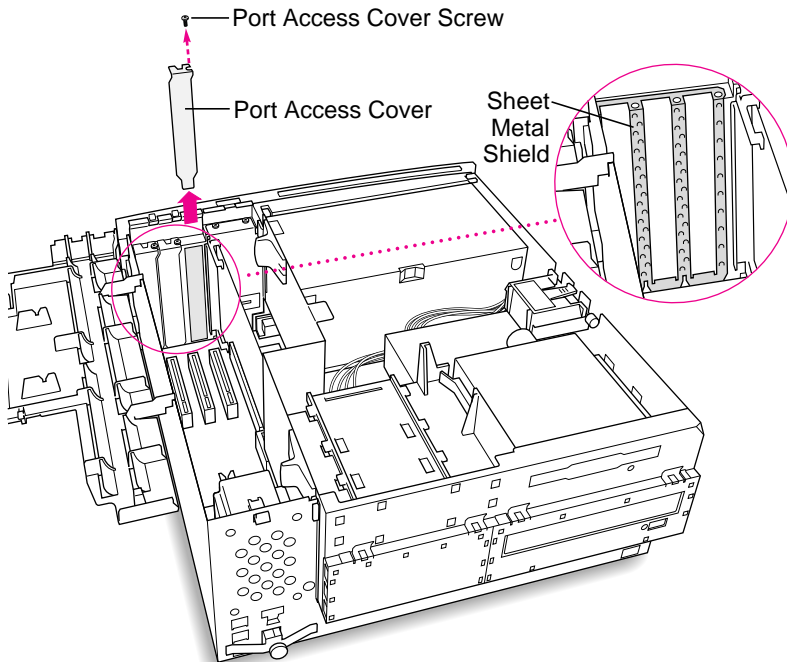

- 2 Remove the screw that holds the port access cover in place.
- 3 Pull out the access cover.

Note: If you remove all three port access covers, be sure the sheet metal shield remains under the edge of the logic board.



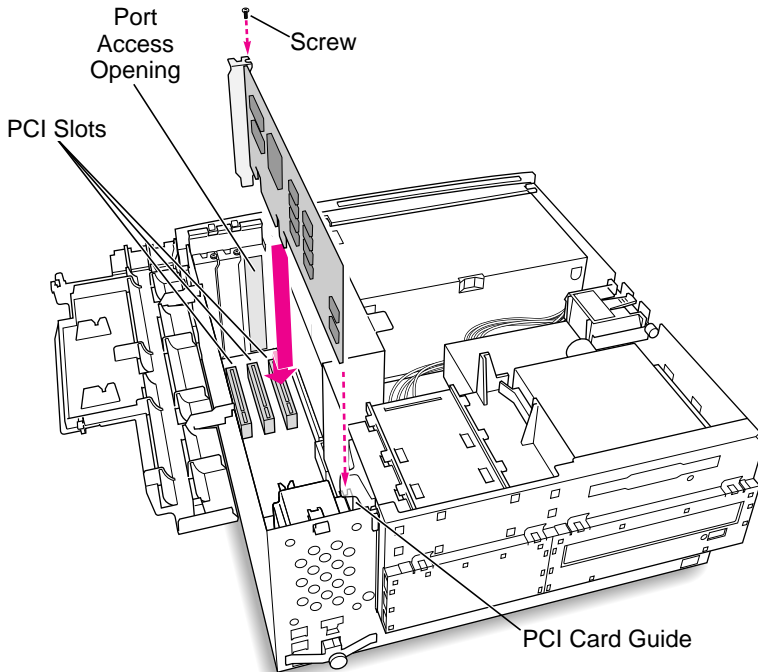

- 4 Align the card connector with the expansion slot and press straight down until the connector inserts all the way into the slot.

Note: It may be helpful to hold the card slightly away from the port access opening until the card fits into the slot.

Note: If the PCI card is a full 12 inches, be sure it fits into one of the three card guides at the front of the computer.



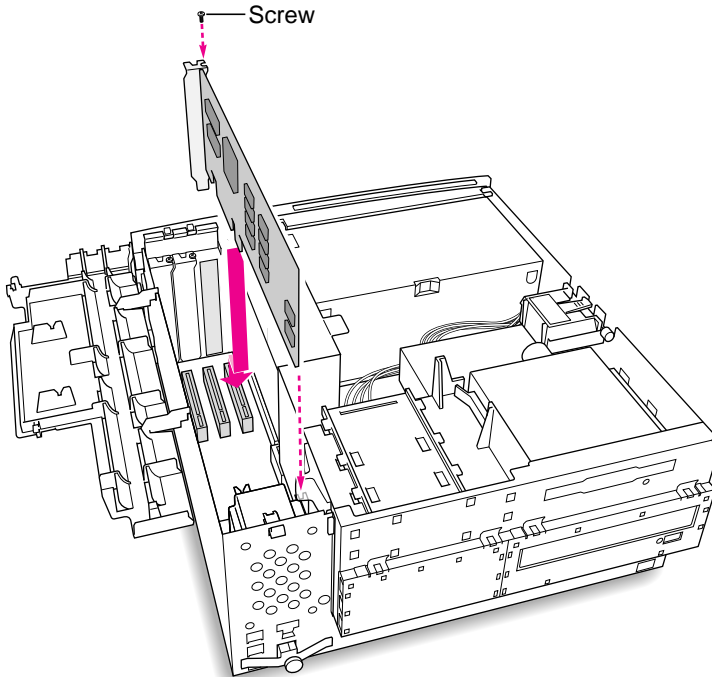

- 5 If you meet resistance, pull the card out and try again.
- 6 To test the connection, pull the card up gently. The card should remain firmly in place.
- 7 Reinstall the screw to secure the card in place.





- 8 Close the expansion card cover.

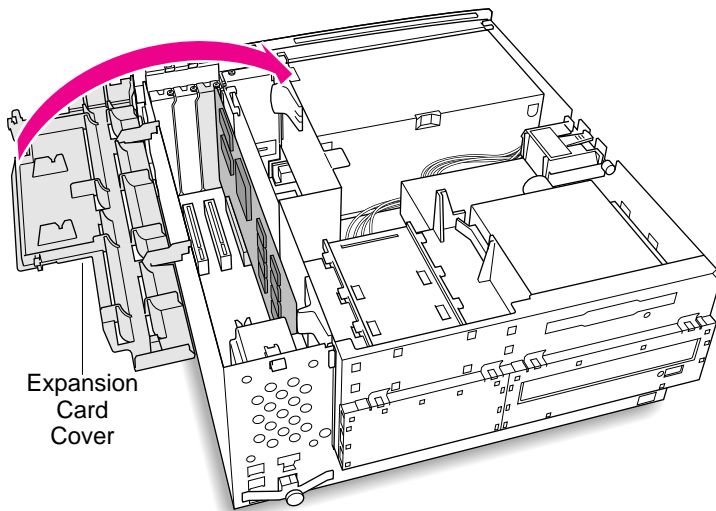



Memory—DRAM or VRAM

Open Chassis

Before you begin, remove the top housing.

- 1 To unlock the chassis, move the release switches toward the inside of the computer.
- 2 Tip the support foot out until it snaps into the locked position.

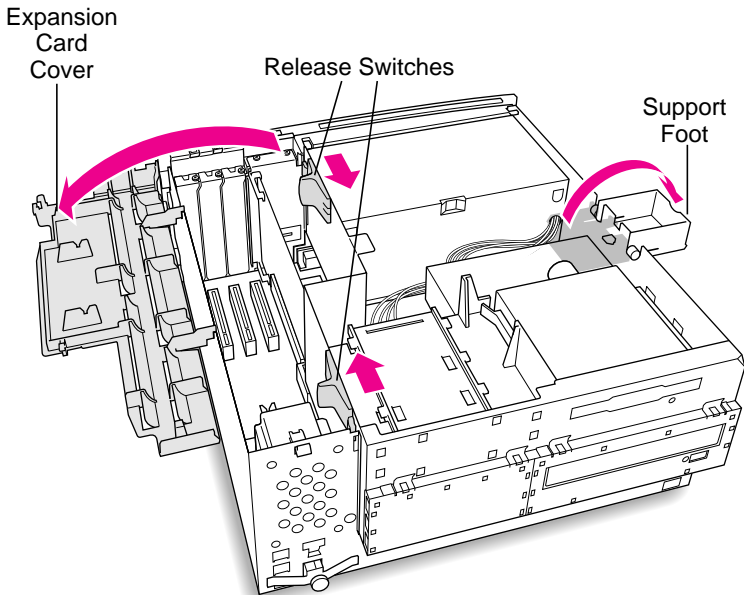



- 3 Lift up on the tab to open the chassis.

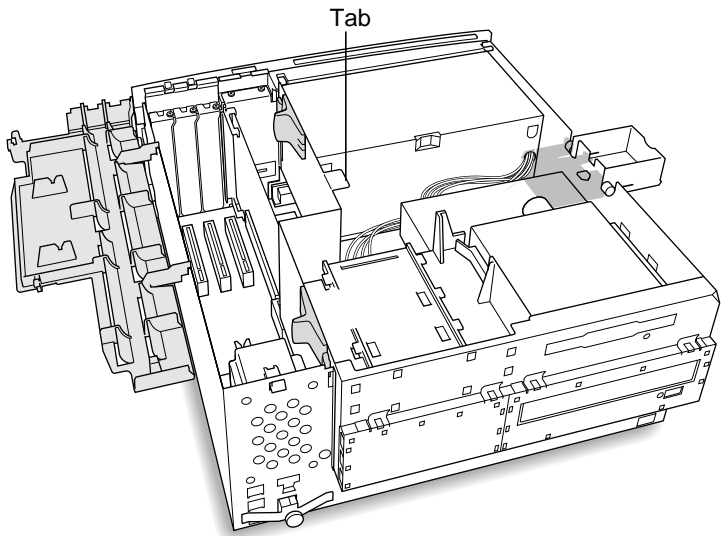



- 4 Swing the chassis up and insert the support arm in the hole.

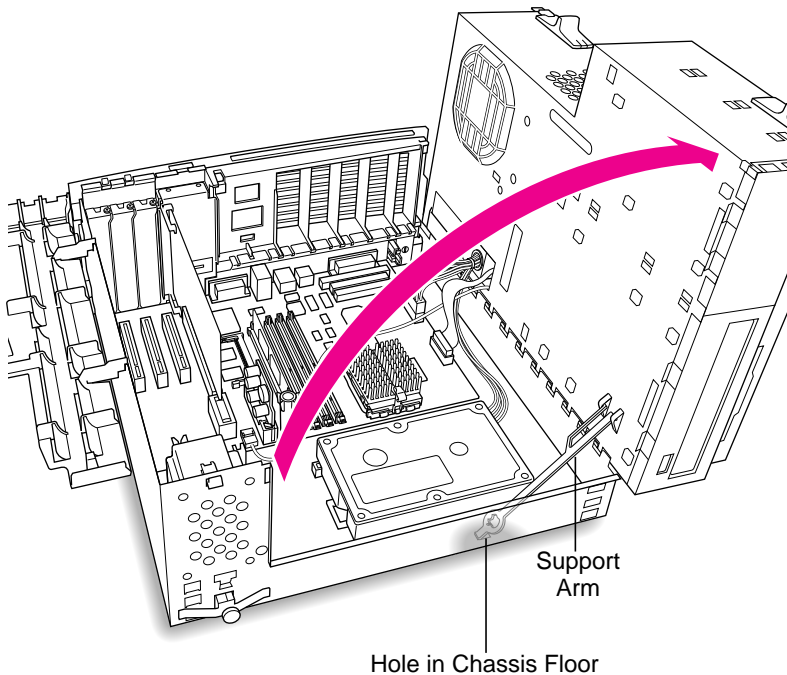

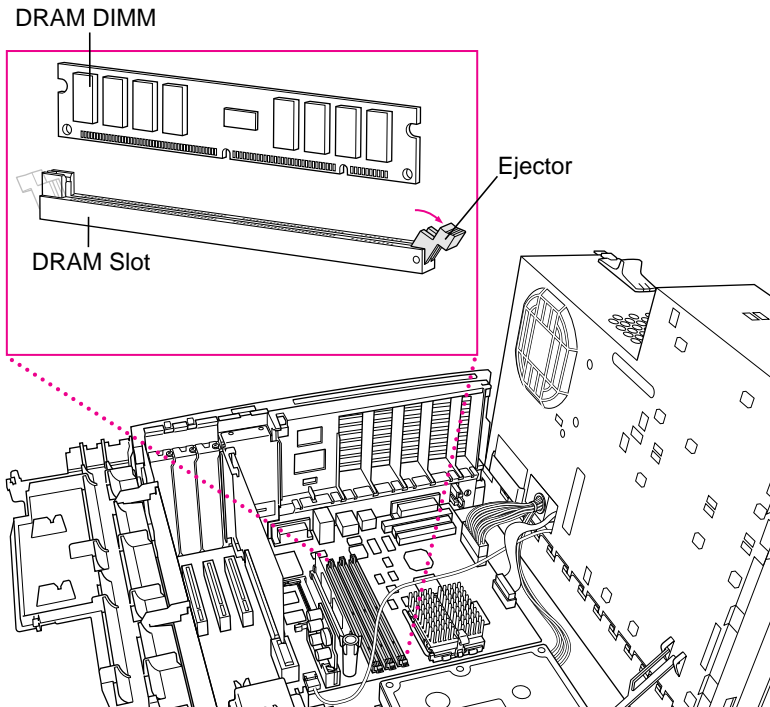

DRAM

Note: DIMM shape and components may vary.

- 1 To remove existing DRAM DIMMs to make room for new ones, push down on the ejectors.



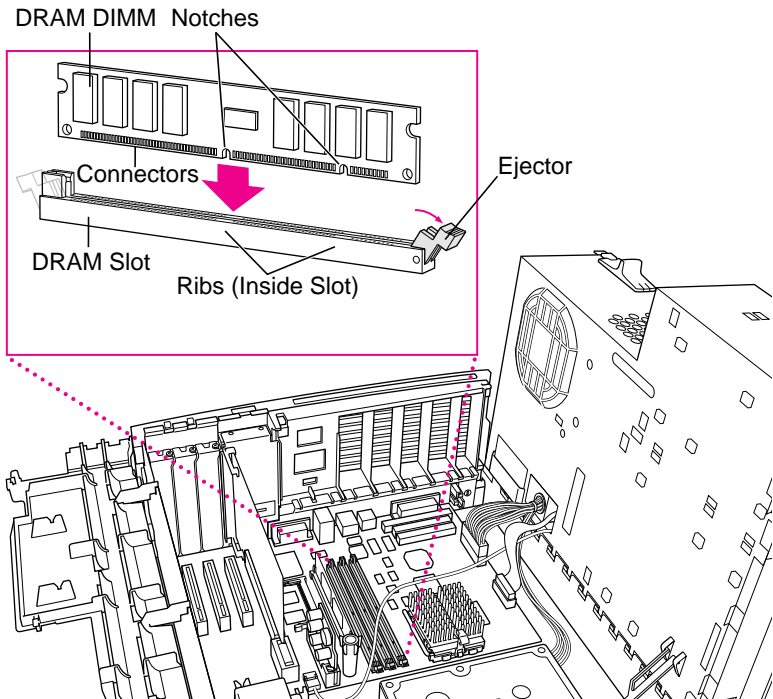

- 2 Align DIMM notches with DRAM slot ribs.

Note: The DIMM is designed to fit in the slot only one way.

- 3 With ejectors open, press the DIMM into the slot.

Note: Slot may have one or two ejectors.





SGRAM DIMM

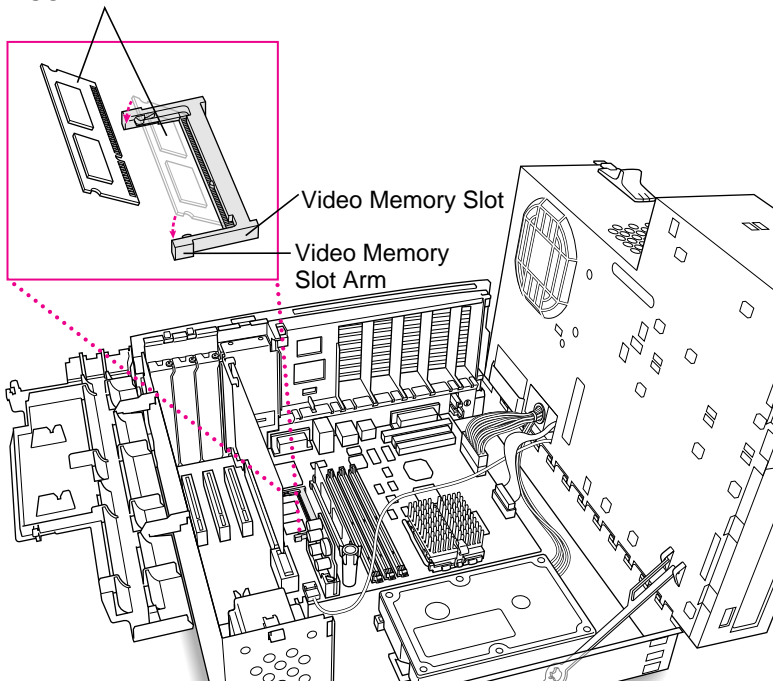

VRAM

Note: SGRAM DIMM shape and components may vary.

- 1 To remove existing SGRAM DIMM, spread arms of video memory slot apart slightly. The SGRAM DIMM will pop up.



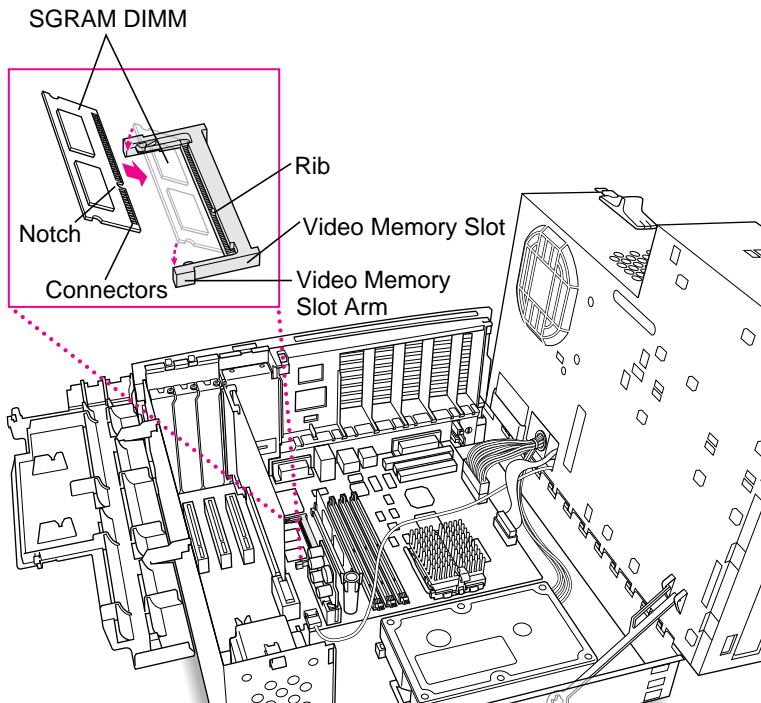

2 Align SGRAM DIMM notches with VRAM slot ribs.

Note: SGRAM DIMM fits into slot only one way.

3 Press the SGRAM DIMM into the slot.

Note: SGRAM DIMM should be flat and parallel to the logic board.





Close Chassis

- 1 Lift up the chassis support arm from the hole on the chassis floor and gently swing the chassis back into place.

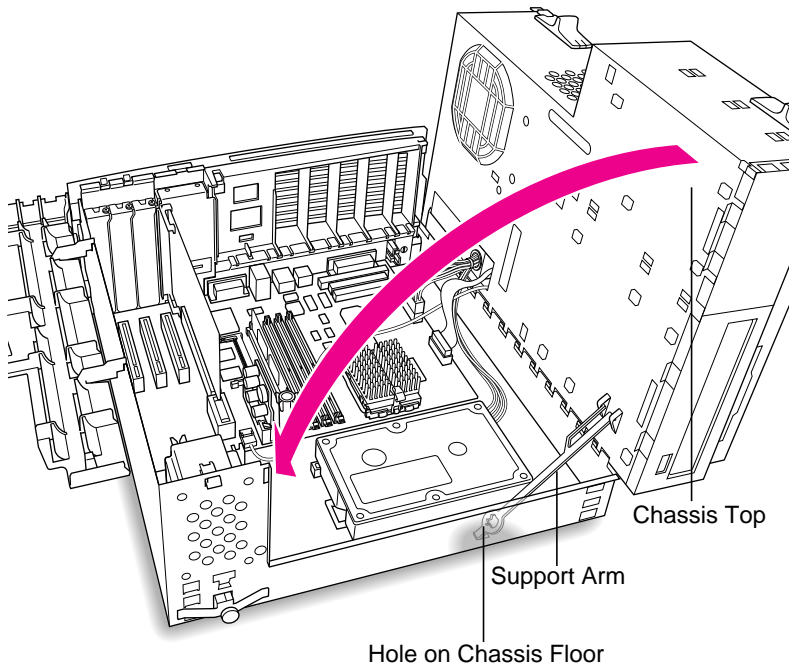

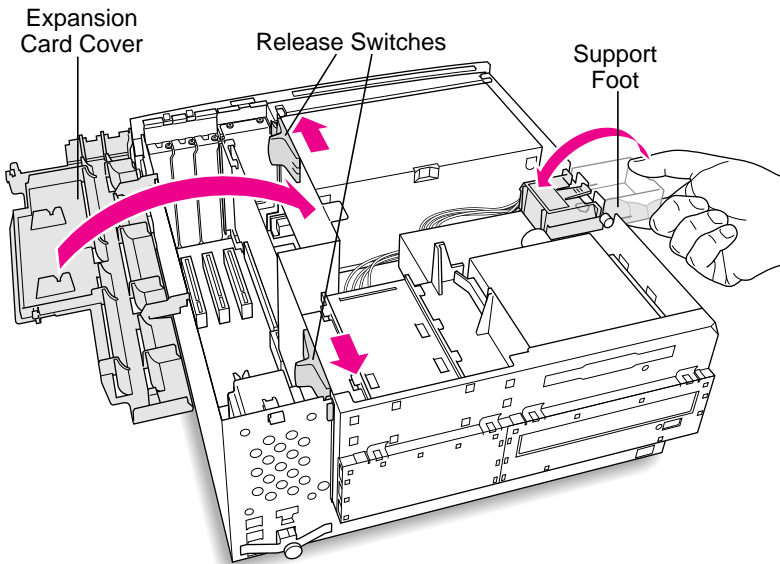

- 2 Close expansion card cover.
- 3 Press the release switches toward the outside of the computer.
- 4 Swing the support foot back inside the computer housing.





Modem Card

Before you begin, do the following:

- Remove the top housing
- Open the internal chassis
- Remove the I/O Card

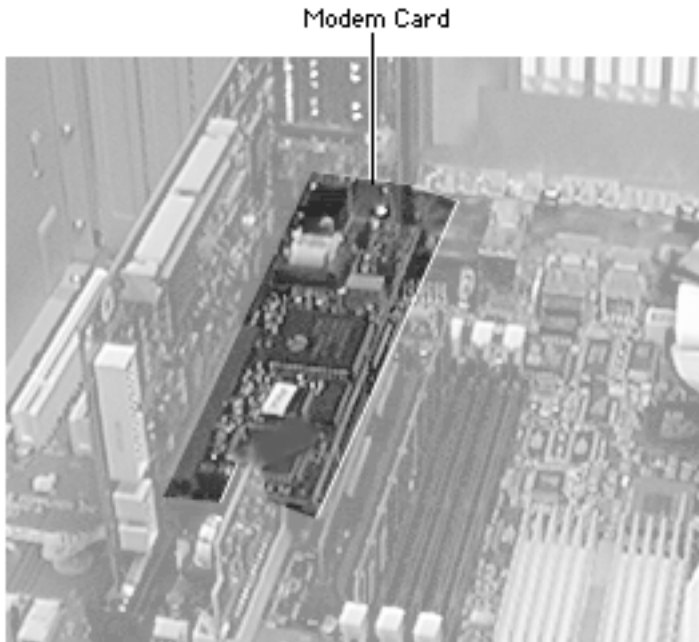

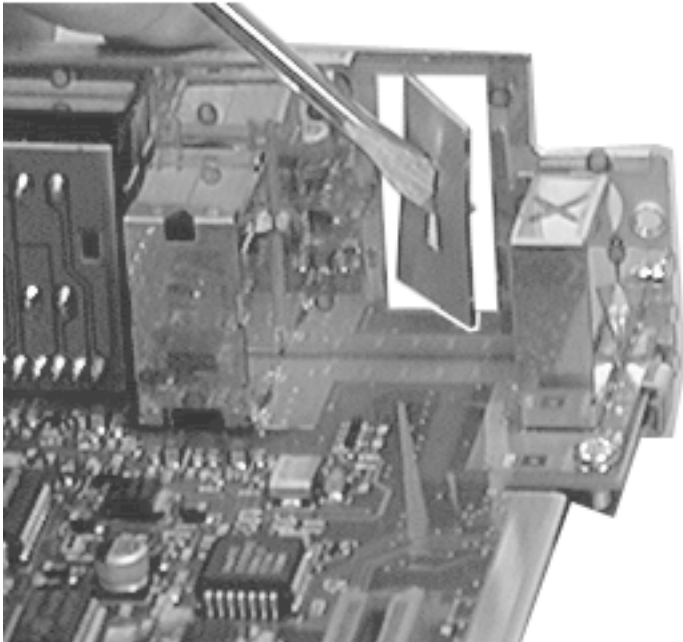

- 1 Insert a small flatblade screwdriver in the modem slot cover on the I/O card.
- 2 Gently twist the screwdriver to pop out the metal modem slot cover.



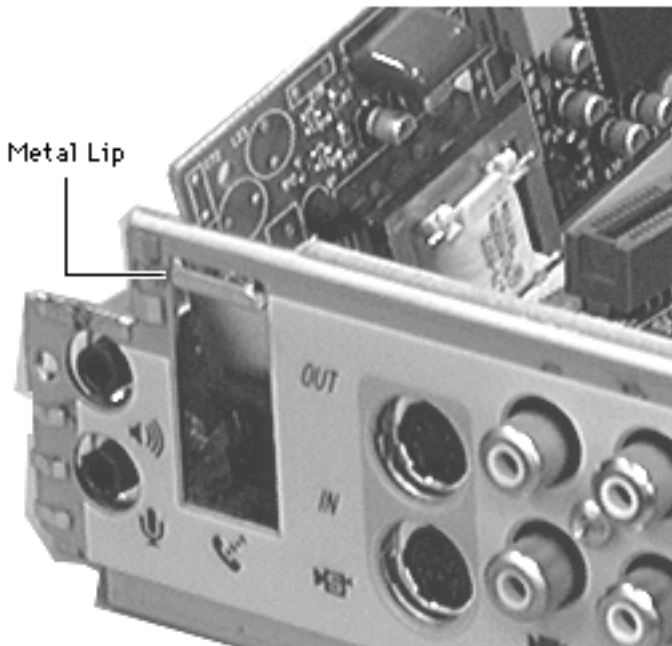

- 3 Holding the modem card at a slight angle to the I/O card, insert the metal lip on the modem card's connector panel through the opening in the I/O card.



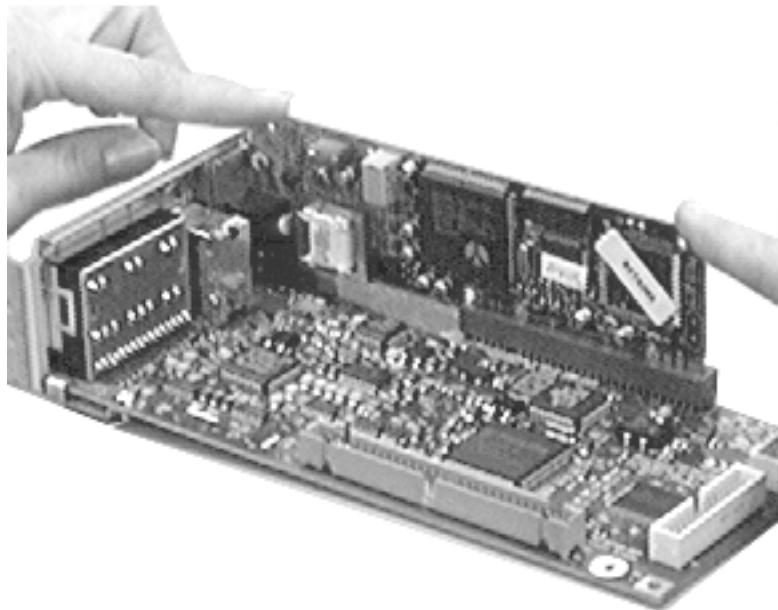

- 4 Gently swing down the modem card so that it is aligned on top of the modem card slot on the I/O card.
- 5 Gently press down evenly on the modem card to install it. Be sure the card is properly seated.



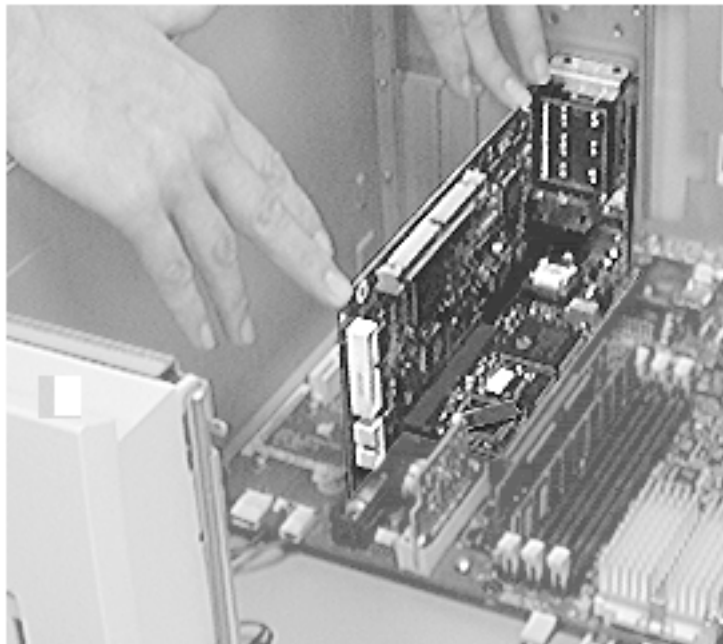

- 6 Reinstall the I/O card in the computer. Be sure to insert the three screws that secure the I/O card to the metal chassis.





Troubleshooting

Power Macintosh G3 Desktop





General

The Symptom Charts included in this chapter will help you diagnose specific symptoms related to your product. Because cures are listed on the charts in the order of most likely solution, try the cures in the order presented. Verify whether or not the product continues to exhibit the symptom. If the symptom persists, try the next cure. (Note: If you have replaced a module, reinstall the original module before you proceed to the next cure.)

For additional assistance, contact Apple Technical Support.





New Components Theory of Operation

New components on the Power Macintosh G3 logic boards and new strategies for parts replacement make troubleshooting these systems significantly different from previous models. Take a moment to read and understand how each of these new components interacts with the system.

Voltage Regulator

The voltage regulator module regulates the voltage for the particular processor used in different Power Mac G3 systems. The voltage regulator provides an easy way to regulate voltage without changing specific resistor values on the logic board. When you replace the logic board, you must transfer the voltage regulator from the old logic board to the new one. (Note: Always try replacing the voltage regulator to resolve power-on problems before replacing the logic board.)





Processor Module

The Power Macintosh G3 logic board comes with a removable processor module. You can replace this module when the logic board or processor module fails. The processor module sits in a ZIF socket for easy removal. Processor modules can be ordered from Service, and each is shipped with the appropriate jumper configuration block to place in location J16. The processor should rarely fail. Replace it only as a last resort.

When replacing the processor module, you must change the processor jumper block and warranty sticker to be compatible with the processor module you are installing. Failure to install the jumper block properly will result in a unit that does not boot up. Refer to “Processor Module” in Take-Apart for installation instructions.





Jumper Location J16

The jumper block you place at location J16 configures the board to work with different processor modules. Use the appropriate jumper block, identified by color, for each processor module. Refer to “Processor Module” in Take-Apart for instructions.

Processor Speed	Jumper Color
233	Red
266	White
300	Black

The jumper block is protected by a void-warranty sticker. End users are not allowed to remove this jumper block. If the sticker has been tampered with on a unit you receive for repair, do not honor the service warranty on the system.





Jumper Location J28

Jumper location J28 controls which power supply the Power Macintosh G3 logic board can accommodate. When you receive a Power Macintosh G3 logic board from Service, you need to place the jumper in the proper location. The power supply used in the Power Macintosh G3 Desktop computer is different from the power supply used in the G3 Minitower computer.

If the logic board is installed in the PM G3 Minitower, the power supply jumper must cover the pins marked “PS”. If the logic board is installed in the PM G3 Desktop model, this jumper must cover the pins marked “Mac”. (Replacement logic boards should come preset for the Desktop model.) When replacing the logic board, be sure to check the power supply jumper setting. If this jumper is missing or set incorrectly for the computer model, the computer will not boot up





I/O Cards

Power Macintosh G3 computers require an I/O card that moves audio and/or video from the main logic board. These cards are placed in the PERCH connector on the main logic board. If the card is not seated correctly, different symptoms appear. Look in the Symptom Charts for details on troubleshooting these cards.

Note: the Power Macintosh G3 computers will boot up without the I/O card installed, but they will not operate properly.





HFS+ Formatted Drives

Some Power Macintosh G3 Desktop computers ship with hard drives that are formatted with HFS and some later models ship with hard drives that are formatted with HFS+ (also referred to as Mac OS Extended format). Before you try to repair a customer's hard drive, it is imperative that you determine how the drive has been formatted.

Norton Utilities version 3.5 is not compatible with HFS+ (or Mac OS Extended format), and in fact, can destroy data on the hard drive. Norton Utilities version 3.5.3 or 3.5.2 will not attempt to repair a drive formatted with Mac OS Extended format and versions 3.5.1 and earlier cannot recognize that a hard drive is in Mac OS Extended format and can result in hard drive corruption and loss of all data on the drive.

Note: When diagnosing hard drive problems, it is important to





verify whether or not the customer may have used the wrong disk repair software for their drive before assuming that the problem is hardware related.

If you experience problems with a hard drive that has been formatted with HFS+, Apple Computer recommends using the version of Disk First Aid included on the system software CD that shipped with the unit. (See the Symantec Web site at <http://www.symantec.com/nu/num-hfs.html> for more information on Norton Utilities and Mac OS Extended format.)

Some other disk utility and disk locking programs are incompatible with Mac OS Extended format. Before you attempt to use a disk utility or disk locking program, make sure the version you have is compatible with Mac OS Extended format. Check the documentation that came with the program or contact the manufacturer or the vendor that supplied the program.

Use the Get Info command in system 8.1 to determine how a hard





drive has been formatted. Drives formatted with HFS will appear as “Mac OS Standard”, while drives formatted with HFS+ will appear as “Mac OS Extended.”

For more information on HFS+ formatting of hard drives, refer to the Technical Info Library, article # 30344.





Cleaning Procedure for Card Connectors

It is possible for residue to build up on the gold edge connector pins on some PCI cards, which could cause a variety of symptoms.

If you are having problems with a PCI card, inspect the connector pins with a magnifying glass. If you find residue, use a pencil eraser to gently clean the pins.





Power Supply Verification

The Power Macintosh G3 logic board requires a “trickle” power of +5V in order to power-up. If this trickle power is not present, the system will not power-up. If the system fails to power-up, follow the procedure outlined below to determine whether or not the problem is related to the power supply.

Note: In order to verify the power supply you will need a voltmeter.

Verification Procedure

Follow the procedures in the Take-Apart chapter to access the power supply.

IMPORTANT: For all the following steps you will want to leave the power supply connector plugged into the logic board during testing.





1. Plug in a known-good power cord into the back of the computer. **Note:** Do NOT power on the computer.

Note: For the next steps, refer to Figure 1 on the next page to identify the pins indicated.

2. Connect the black lead of the voltmeter to pin 16 of the power supply connector. Connect the red lead of the voltmeter to pin 9 of the 20-pin power supply cable. The voltmeter should measure approximately +5V.

If you do not measure +5V then re-check the voltmeter connections and check for voltage again. If voltage is still not present then replace the power supply; otherwise, continue on to the next step.

If you DO measure +5V on pin 9, the power supply is likely OK. Continue on to the next step for further verification.



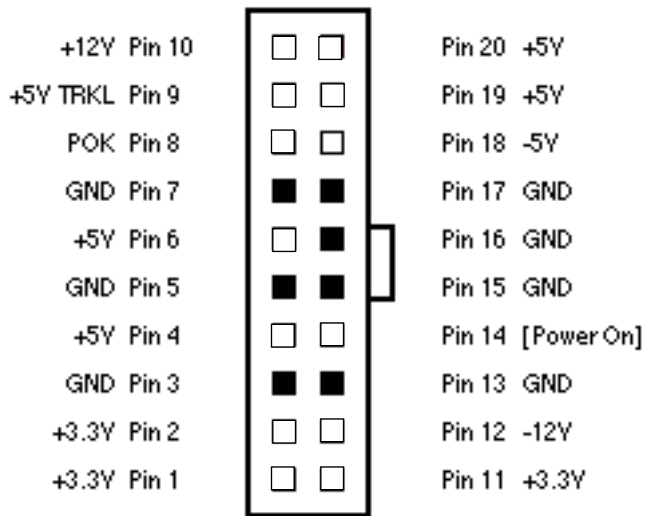

Figure 1. Power Supply 20-Pin Connector





3. Power up the computer by pressing the On/Off button on the front of the Power Mac G3. **Note:** Verify that the power on/off cable is plugged into connector J30.

If the computer powers up normally then the power supply is OK. If the power supply does not power up, continue on to the next step.

4. Check to see if the power supply fan is spinning.

If the power supply fan is not spinning then verify that the jumper at connector J28 is installed in the correct location (on the Minitower, the correct location is “PS/2 Supply”; on the Desktop, the correct location is “MAC Supply”); otherwise, continue to the next step.

5. Connect the black lead of the voltmeter to pin 16 of the power supply connector. Connect the red lead of the voltmeter to pin 1 of the 20-pin power supply cable. The voltmeter should





measure approximately +3.3V.

If you do not measure +3.3V, re-check the voltmeter connections and check for voltage again. If voltage is still not present, replace the power supply; otherwise, continue on to the next step.

6. Connect the black lead of the voltmeter to pin 16 of the power supply connector. Connect the red lead of the voltmeter to pin 4 of the 20-pin power supply cable. The voltmeter should measure approximately +5V.

If you do not measure +5V, re-check the voltmeter connections and check for voltage again. If voltage is still not present, replace the power supply; otherwise, continue on to the next step.

7. Measure the voltage of pin 10 of the 20-pin power supply connector. The voltage should measure approximately +12V.





If you do not measure +12V, re-check the voltmeter connections and check for voltage again. If voltage is still not present, replace the power supply; otherwise, continue on to the next step.

8. The testing is complete. You have just verified that the power supply is not faulty and is not the cause of the “No power-up” problem.





Symptom Charts

System

Fan on power supply is running, but no startup chime, screen is black, drive not accessed at startup, and no LED on front of system

- 1 Verify power supply voltage switch is set correctly for your region (see “Voltage Switch” in Basics chapter for more information).
- 2 Check jumper block J28. Be sure setting is correct for type of power supply installed (see “Logic Board” in Take-Apart chapter for more information).
- 3 Check jumper block configuration at J16. Make sure jumper block is correct color for processor type installed (see “Processor Module” in Take-Apart chapter for more information) and that it is installed in the correct direction.
- 4 Reseat voltage regulator.
- 5 Reseat processor module. Make sure locking arm is in down position.





- 6 Reseat ROM DIMM.
- 7 Replace voltage regulator.
- 8 Replace logic board.
- 9 Replace processor module.

Fan is running, LED is on, drive is accessed at startup, but no startup chime and screen is black

Reseat ROM DIMM.

No apparent power, fan isn't running, no LED

- 1 Verify power cord is attached securely at both ends.
- 2 Verify that the power outlet is good.
- 3 Verify ADB cable is good and connected properly.
- 4 Check internal power cables and verify they are attached securely at both ends.
- 5 Check jumper block J28. Make sure setting is correct for type of power supply installed (see "Logic Board" in Take-





- Apart chapter for more information).
- 6 Reset Cuda chip. (Refer to “The Cuda Chip” in Basics chapter for instructions.)
 - 7 Reset logic board. (Refer to “Resetting the Logic Board” in Basics chapter for instructions.)
 - 8 Replace power cord.
 - 9 Reseat voltage regulator.
 - 10 Check the power supply by following the procedures in “Power Supply Verification” outlined earlier in this troubleshooting chapter.
 - 11 Replace logic board.





Computer begins to power up, the fan and hard drive are spinning, the power LED is lit, but there is no video and the boot chime is followed by sound of breaking glass

- 1 Reseat ROM DIMM.
- 2 Reseat DRAM DIMMs. (Note: the computer does not ship with any on-board memory. You must have a DRAM DIMM installed for the computer to boot properly.)
- 3 Test for a bad DRAM DIMM by removing the DIMMs one at a time (replacing each one afterwards). Replace any faulty DRAM DIMMs.
- 4 Verify external SCSI cabling is secure.
- 5 Verify external SCSI devices are good.

Clicking, chirping, thumping, or rubbing

- 1 Remove all PCI cards and test unit. If problem does not occur with cards removed, begin replacing cards one at a time to determine which card is causing problem. Replace problem card with known-good card.
- 2 Remove hard drive. If problem no longer occurs, replace hard drive with a known-good drive.
- 3 Replace power supply.
- 4 Replace processor module.





System shuts down
intermittently

- 5 Replace logic board.
 - 6 Replace floppy drive cable.
 - 7 Replace floppy drive.
 - 8 Replace I/O card.
-
- 1 Make sure air vents are clear. Thermal protection circuitry may shut down system. After 30 to 40 minutes, system should be OK.
 - 2 Make sure power cord is plugged in firmly.
 - 3 Replace power cord.
 - 4 Check battery.
 - 5 Reset Cuda chip. (Refer to “The Cuda Chip” in Basics chapter for instructions.)
 - 6 Reset logic board. (Refer to “Resetting the Logic Board” in Basics chapter for instructions.)
 - 7 Replace power supply.
 - 8 Replace logic board.
 - 9 Replace processor module.





System
intermittently
crashes or hangs

- 1 Verify system software is version 8.0 or later with enabler 770.
- 2 Verify software is known-good. Do a clean install of system software.
- 3 Verify software is Power Macintosh compatible (contact developer). Also, try booting with extensions off to determine if there are system init problems.
- 4 Clear parameter RAM. Hold down <Command> <Option> <P> <R> during startup but before "Welcome to Macintosh" appears.
- 5 Remove all SDRAM DIMMs and try replacing them one at a time to test. Replace any bad DIMMs.
- 6 Replace logic board.
- 7 Replace processor module.





During startup, following message is displayed, "This startup disk will not work on this Macintosh model...."

- 1 Verify startup disk is good.
- 2 Verify system software is version 8.0 or later with enabler 770.
- 3 Do a clean install of system software.





Error Chords

One-part error chord (sound of breaking glass) sounds during startup sequence

- 1 Disconnect IDE data cable from hard drive and reboot system. If startup sequence is normal, initialize hard drive. Test unit again with IDE data cable connected. If error chord still sounds, replace hard drive.
- 2 Disconnect floppy drive cable from floppy drive and reboot system. If startup sequence is normal, replace floppy drive.
- 3 Reseat processor module.
- 4 Replace logic board.
- 5 Replace processor module.





Video

Screen is black, but boot tone is present, drive operates, fan is running, and LED is lit

- 1 Adjust brightness on monitor.
- 2 Clear parameter RAM. Hold down <Command> <Option> <P> <R> during startup but before "Welcome to Macintosh" appears.
- 3 Reset Cuda chip. (Refer to "The Cuda Chip" in Basics chapter for instructions.)
- 4 Reset logic board. (Refer to "Resetting the Logic Board" in Basics chapter for instructions.)
- 5 Replace monitor cable.
- 6 Remove all SDRAM DIMMs and try replacing them one at a time to test. Replace any bad DIMMs.
- 7 Test with known-good monitor. Replace monitor if necessary. Refer to appropriate monitor manual to troubleshoot defective monitor.
- 8 Replace logic board.
- 9 Replace processor module.





Screen is black, no boot tone and drive does not operate, but fan is running and LED is lit

- 1 Reset Cuda chip. (Refer to “The Cuda Chip” in Basics chapter for instructions.)
- 2 Reset logic board. (Refer to “Resetting the Logic Board” in Basics chapter for instructions.)
- 3 Remove all SDRAM DIMMs and try replacing them one at a time to test. Replace any bad DIMMs.
- 4 Replace logic board.
- 5 Replace power supply.
- 6 Replace processor module.

Boot tone is present and screen lights up, but nothing is displayed on screen

- 1 Reset Cuda chip. (Refer to “The Cuda Chip” in Basics chapter for instructions.)
- 2 Reset logic board. (Refer to “Resetting the Logic Board” in Basics chapter for instructions.)
- 3 Replace monitor cable.
- 4 Test with known-good monitor. Replace monitor if necessary. Refer to appropriate monitor manual to troubleshoot defective monitor.





- 5 Replace logic board.
- 6 Replace processor module.

Horizontal flickering lines when viewing Apple Video Play application with TV Mirroring on

Replace the Audio/Video card with a Version II Audio/Video card (p/n 661-2044).

TV Mirroring is enabled but no image is appearing on TV

Refer to TIL article 24816 for how to verify that video output from Audio/Video card is working.





Floppy Drive

Internal floppy drive does not operate

- 1 Replace floppy disk with known-good disk.
- 2 Replace floppy drive cable.
- 3 Replace floppy drive.
- 4 Replace logic board.
- 5 Replace processor module.

During system startup, disk ejects; display shows icon with blinking "X"

- 1 Replace disk with known-good system disk.
- 2 Replace floppy drive cable.
- 3 Replace floppy drive.
- 4 Replace logic board.
- 5 Replace processor module.

Disk does not eject

- 1 Switch off computer. Hold down mouse button while you switch computer on.
- 2 Replace floppy drive cable.
- 3 Replace floppy drive.





	<ol style="list-style-type: none">4 Replace logic board.5 Replace processor module.
Drive attempts to eject disk, but doesn't	<ol style="list-style-type: none">1 Reseat floppy drive bezel and drive so bezel slot aligns correctly with drive.2 Replace floppy drive.
Internal floppy drive runs continuously	<ol style="list-style-type: none">1 Replace disk with known-good floppy disk.2 Replace floppy drive cable.3 Replace floppy drive.4 Replace logic board.5 Replace processor module.
MS-DOS drive does not recognize a disk formatted on a 1.4 MB drive	To read and write files with either MS-DOS or 1.4 MB drive, format all disks with MS-DOS drive first.





Hard Drive

Single internal hard drive does not operate; drive doesn't spin

- 1 Replace hard drive power cable.
- 2 Replace hard drive. If problem resolved, reinstall IDE device driver and system software.
- 3 Replace power supply.

No internal SCSI drives operate

- 1 Verify there are no duplicate SCSI device addresses on a single SCSI bus.
- 2 Disconnect external SCSI devices and check for proper termination. Only last device in SCSI chain should be terminated.
- 3 Check internal SCSI devices for proper termination.
- 4 Replace internal SCSI data cable to which non-operational devices are attached.
- 5 Replace power supply.
- 6 Replace logic board.
- 7 Replace processor module.





Works with internal or external SCSI devices but not with both

- 1 Verify there are no duplicate SCSI device addresses
- 2 Replace terminator on external SCSI device.
- 3 Verify that SCSI device at end of internal SCSI data cable is only device terminated.
- 4 Refer to appropriate manual to troubleshoot defective external device.





Peripherals

Cursor does not move

- 1 Check mouse connection.
- 2 Inspect inside of mouse for buildup of dirt or other contaminants. Clean mouse if necessary.
- 3 If mouse was connected to keyboard, connect mouse to computer ADB port instead. If mouse works, replace keyboard.
- 4 Replace ADB cable.
- 5 If mouse does not work in any ADB port on computer, replace mouse.
- 6 Replace logic board.
- 7 Replace processor module.

Cursor moves, but clicking mouse button has no effect

- 1 Boot from floppy or bootable CD.
- 2 Replace mouse.
- 3 Replace logic board.





Double-click doesn't open application, disk, or server

- 1 Remove duplicate system folders.
- 2 Clear parameter RAM. Hold down <Command> <Option> <P> <R> during startup but before "Welcome to Macintosh" appears.
- 3 If mouse was connected to keyboard, connect mouse to computer ADB port instead. If mouse works, replace keyboard.
- 4 If mouse does not work in any ADB port on computer, replace mouse.
- 5 Replace logic board. Retain customer's DIMMs.

No response to any key on keyboard

- 1 Check keyboard connection to ADB port.
- 2 Replace keyboard cable.
- 3 Replace keyboard.
- 4 Replace logic board.





Known-good serial printer does not work

- 1 Verify you have correct version of system software.
- 2 Verify that Chooser is set correctly.
- 3 Reinstall correct printer drivers.
- 4 Do clean install of system software.
- 5 Replace printer interface cable.
- 6 Replace logic board. Retain customer's DIMMs.

Known-good network printer does not print

- 1 Check network connections.
- 2 Verify you have correct version of system software.
- 3 Verify that Chooser is set correctly.
- 4 Does printer show up in Chooser? If so, do clean install of system software and/or network and printer software.
- 5 Replace logic board. Retain customer's DIMMs.

Color StyleWriter 4500 printer does not respond

Upgrade to the Color StyleWriter 4500 driver, version 1.1 or later. Refer to this URL online: <http://www.apple.com/support/>





CD-ROM Drive

CD-ROM drive does not work

- 1 Try using known-good compact disc.
- 2 Replace CD-ROM drive mechanism.

Macintosh does not display CD-ROM icon once CD is inserted in drive

- 1 Try using known-good compact disc.
- 2 Verify CD-ROM software is installed.
- 3 Reinstall CD-ROM software. You may have to use an external CD-ROM drive.
- 4 Reseat CD-ROM data cable at logic board connector as well as at CD-ROM connector.
- 5 Replace CD-ROM drive mechanism.
- 6 Replace CD-ROM data cable.

CD-ROM drive does not eject discs

- 1 Install poron bumpers (part number 922-3554) on the back of the CD-ROM carrier, where the carrier touches the metal tabs on the chassis. First install two bumpers, one on each end of the carrier, and test to see that the CD-ROM tray





ejects properly. (**Note:** Be sure to push the CD carrier in all the way before testing; if the CD device is not properly seated, the problem may recur.) If the tray still does not eject properly, install an additional bumper on each side, stacking them on top of the bumpers you previously installed, and test again. You may need to install up to three bumpers on each side before the tray ejects properly. (Graphic follows on the next page.)

- 2 Install a CD bezel shim (part number 922-3911) on the back of the CD bezel on the eject button arm. (Graphic follows on the next page.) You may need to use a combination of bumpers and shim before the CD-ROM tray ejects properly.



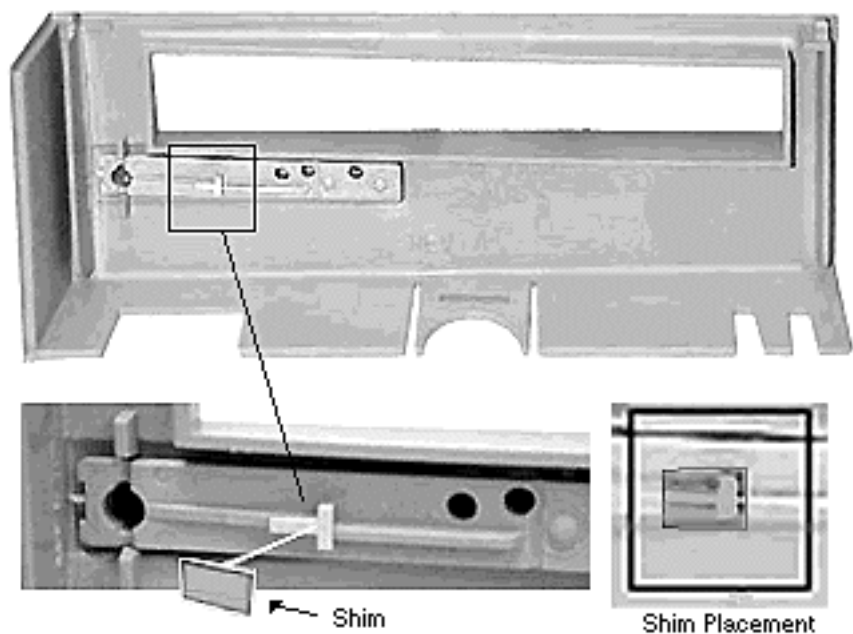
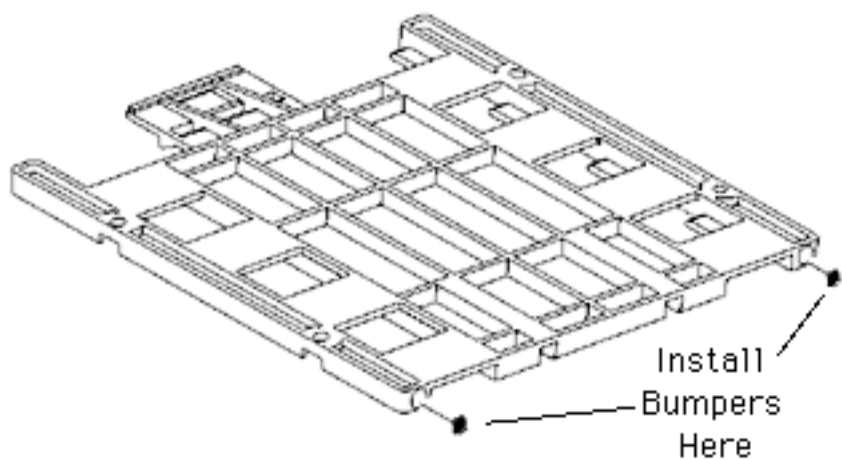



CD-ROM drive ejects
at startup time

Adjust the CD-ROM drive carrier to mount as far forward as possible to allow the CD-ROM Drive to mount as far back as possible. Then, after mounting the top cover securely to the chassis, pull the cover as far forward (towards you as you face the computer) as possible to create space between the bezel button and the CD-ROM button.





CD-ROM drive vibrates and is unusually loud when CD spins

Install rubber bumper (part number 922-3678) on the side of the CD-ROM drive as shown in the following graphic.

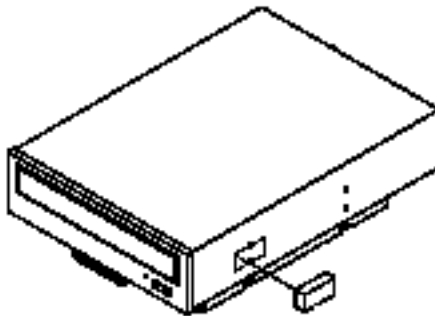

Place the rubber foot between the two screws as shown.





Miscellaneous

No sound from speaker

- 1 Disconnect any microphones or external speakers.
- 2 Verify that volume setting in Control Panel is adequate and mute is not checked.
- 3 Clear parameter RAM. Hold down <Command> <Option> <P> <R> during startup but before "Welcome to Macintosh" appears. Verify speaker is plugged into logic board.
- 4 Plug headphones or external speakers into the external jack. If the the external jack works, replace the internal speaker or logic board. If the external jack doesn't work, proceed to the next step.
- 5 Replace I/O Audio card.
- 6 Replace speaker.
- 7 Replace logic board.

Ethernet connection drops off line by itself

Install Ethernet driver 2.0.4 or later.





Exploded View

Power Macintosh G3 Desktop



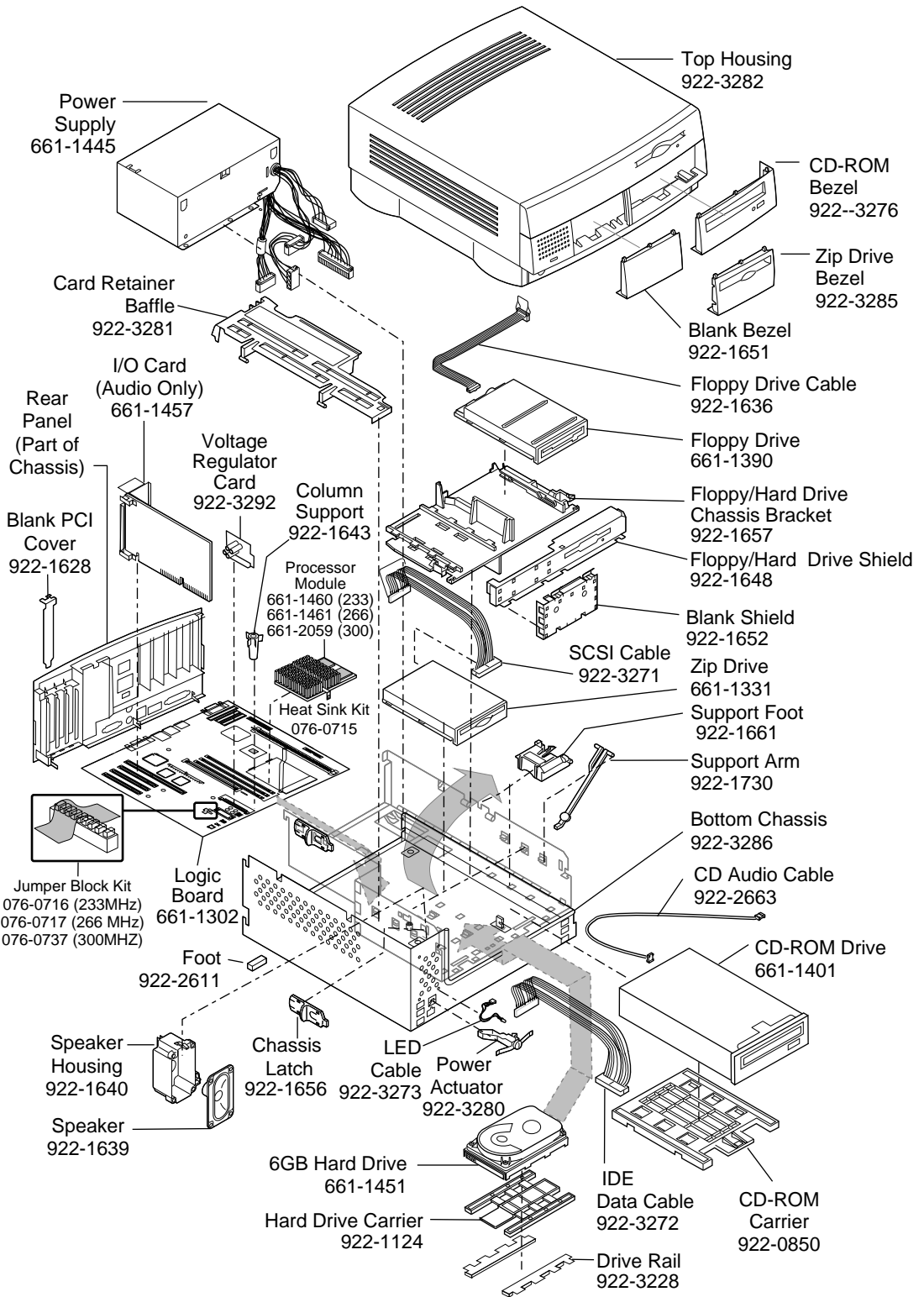

Product family configurations may vary.

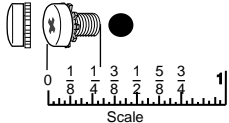
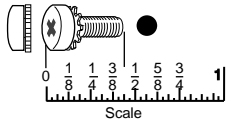
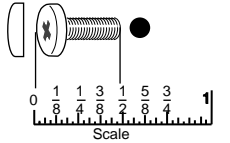

Power Macintosh G3 Desktop Screw Matrix

<p>922-1203 w/lock washer</p> <p>PCI Covers (1)ea =3 Power Supply Case to swing Chassis (1) (2) on rear side of Power Supply... Total (3) PCI Cards (2)</p>  <p>Scale</p>	<p>922-2739 w/lock washer</p> <p>Floppy Drive to Carrier (4) CD-ROM Drive to Carrier (4) Zip-Drive to Carrier (4) Hard Drive Bracket to Chassis (2)</p>  <p>Scale</p>	<p>922-3240</p> <p>Logic Board in colum(1) Logic Board to Ground wire (1)</p>  <p>Scale</p>
---------------------------------------------------------------------------------------------------------------------------------------------------------------------------------------------------------------------------------------------------------------------------------------------	-------------------------------------------------------------------------------------------------------------------------------------------------------------------------------------------------------------------------------------------------------------------------------------	-------------------------------------------------------------------------------------------------------------------------------------------------------------------------------------------------



About Your Optional Power Macintosh Audio/Video Card

The information in this update describes the additional capabilities of Power Macintosh computers that are equipped with an optional Audio/Video (AV) card. For more information on setting up or using your Power Macintosh computer, see the setup manual that came with your computer.

Left and Right RCA-Type Audio Ports

In addition to the standard sound input and output ports, the Power Macintosh AV card provides additional sound input and output capabilities through RCA-type connectors. These connectors are found on devices such as videocassette recorders (VCRs) and tape decks. The RCA-type ports are color-coded: red for right, and white for left. (The yellow ports are for connecting video equipment.)

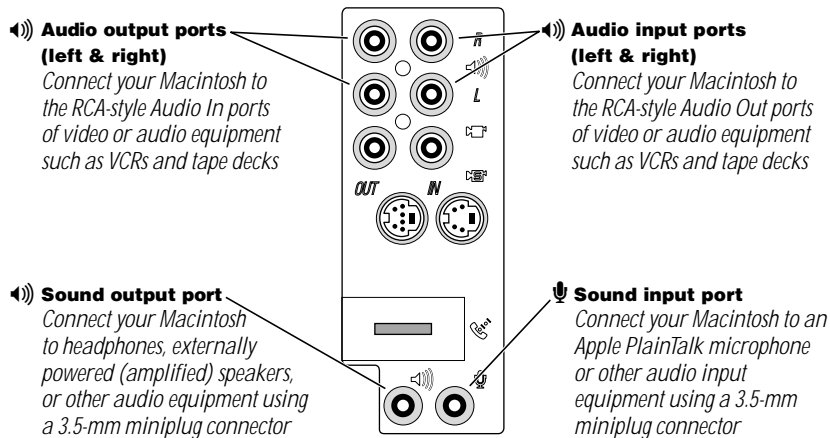

The left and right RCA-type ports accept this type of connector:



RCA-type plug

If your equipment has a different connector, you can purchase an adapter at an electronics supply store.

Connecting Audio Equipment Using the RCA Ports

To connect audio equipment using the RCA ports on the AV card, follow the steps below. For instructions on connecting an audio device using the standard sound input and output ports, see the setup manual that came with your computer.

- 1** Make sure that the audio equipment has a cable like this one that has two RCA plugs at each end:



- 2** Shut down the computer, turn off the audio equipment, and place the equipment near the computer.
- 3** Attach cables to the audio equipment following the instructions that came with the equipment.
- 4** If your audio equipment is a sound input device, such as a tape deck, audio CD player, or VCR, attach it to the RCA-type left and right audio input ports (◀)).
- 5** If your audio equipment is a sound output device, such as amplified speakers, attach it to the optional RCA-type left and right audio output ports (▶)).

The following illustration shows a typical cable arrangements for a tape deck connected with RCA-type connectors.

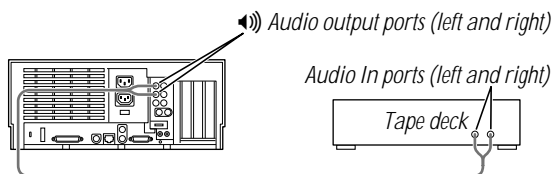

- 6** Turn on the computer and the audio equipment.



Connecting Video Equipment

The Power Macintosh AV card provides additional ports for connecting video equipment so that you can view TV and other video images on your computer monitor and store the images on your hard disk. You can also view the Macintosh desktop on a television screen attached to the computer and record images from the desktop to a videocassette recorder (VCR).

Your Macintosh can work with two major video formats:

- Composite video, which is used by most televisions, most VCRs, and laserdisc players. Composite video devices plug into the computer's RCA-type video ports (IN and OUT).
- S-video, which is a high-quality video format used by many video cameras, VCRs, and televisions. S-video devices plug into the computer's S-video ports (IN and OUT).

The illustration below shows the computer's video input and output ports. (The RCA-type ports are color-coded: yellow for composite video, red for right audio, and white for left audio.)

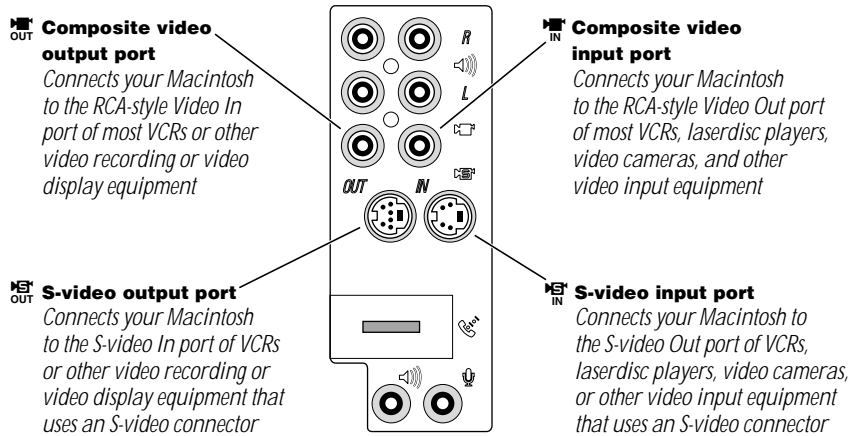

The S-video input and output ports accept S-video connectors, and the composite video input and output ports accept RCA-type connectors.

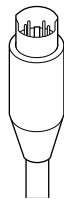

S-video connector



RCA-type connector

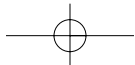

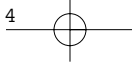

Note: The S-video input port is compatible with both seven-pin and four-pin S-video connectors.

Important The S-video connector is a round plug with several small metal pins. It resembles other Macintosh connectors, such as those for a printer, modem, mouse, or keyboard. Don't confuse the connectors; they're not interchangeable.

Depending on what kind of ports are available on your video equipment, you'll need different cables (available at an electronics supply store).

- If your equipment has an S-video Out port, you'll need a video cable with S-video connectors at each end, and two audio cables with RCA-type connectors at each end. (The audio cables can be separate, or joined like the one in the illustration.)

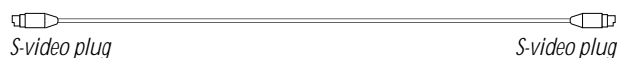



- If your equipment has an RCA Video Out port, you'll need one video cable with RCA-type connectors (plugs) at each end, and two audio cables with RCA-type connectors at each end. (The cables can be separate, or joined like the one in the illustration.)



Connecting Video Equipment for Input to the Computer

When you connect video equipment to the video input port on your computer, you can view video on your monitor, capture video images, and hear the sound from the video equipment through the computer's speaker. The instructions that follow are for connecting a stereo VCR and video camera, but you can use them as a model for connecting your computer to any video equipment.

To connect a VCR or video camera for input, do the following:

- 1** Shut down the Macintosh and turn off the VCR or video camera.
- 2** Attach one end of the video cable to the Video Out port on the video equipment.
Follow the directions that came with the VCR or camera.
- 3** Plug the other end of the video cable into either the S-video input port () or the yellow composite video input port () on the Macintosh.

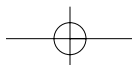

If the S-video connector doesn't slide easily into the port, check the pin alignment and try again. Don't use force, which could damage the computer or cable.

- 4 Plug the RCA-type connectors on the audio cables into the left and right RCA Audio Out ports on the VCR or camera.
- 5 Plug the RCA-type connectors on the audio cables into the left and right RCA input ports (◀) on the computer.

If the cable is color-coded, the red connector is for the right port, and the black or white connector is for the left port.

The next four illustrations show S-video connections and composite video connections for both a VCR and a camera. Your finished connections should look like one of the following:

S-video connection for input from a VCR

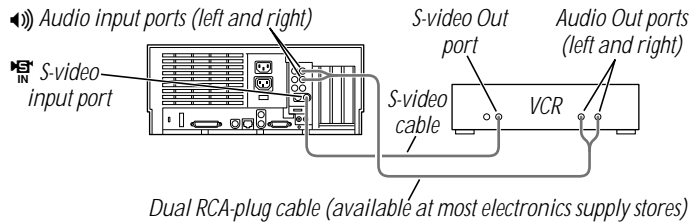

Composite video connection for input from a VCR

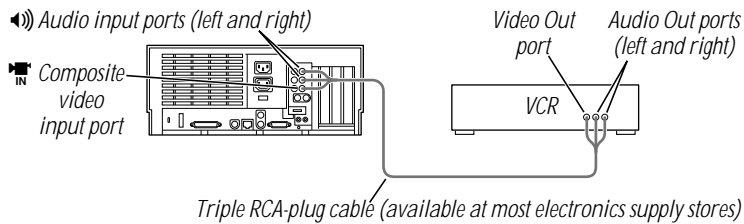

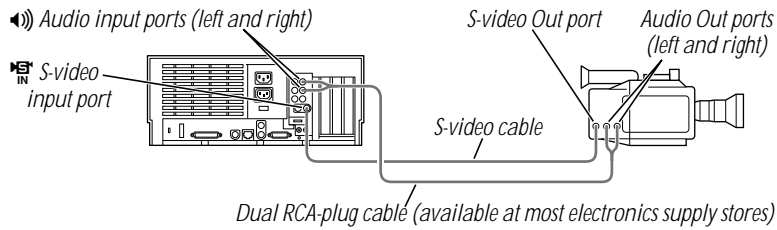
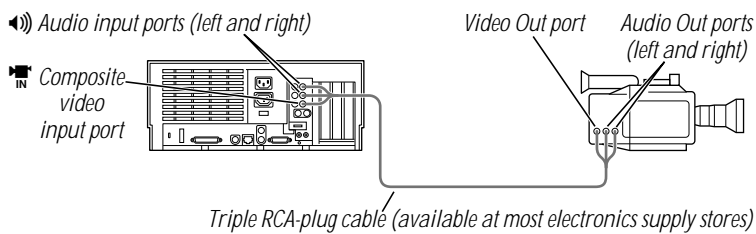
S-video connection for input from a camera**Composite video connection for input from a camera**

- 6** Turn on the computer and the VCR or camera.
- 7** To hear or capture on your computer the audio coming into the RCA input ports, open the Monitors & Sound control panel, click the Sound button, and make sure that the RCA input ports are the selected sound input source.

Click the button labeled  for help.

You can now begin working with the video equipment connected to your computer. To learn more about using the AV features of your computer to play or capture video on your computer, open Mac OS Help (available in the Help menu) and look up “video” in the index.



Connecting Video Equipment for Output From the Computer



You can connect a VCR to record computer images and audio on videotape. The VCR records what is happening on the computer's monitor, sounds generated by the computer, and speech spoken into a microphone if one is connected. This capability is useful for creating video presentations or software demonstrations.

Note: The video out ports are primarily intended for recording what is happening on the computer's monitor. You can use video-editing software to save captured and edited video on a VCR if the video-editing software supports the use of a single monitor. However, to get full video-editing support with independent monitor and video (or TV) output, you need to purchase and install a third-party video capture PCI card.

To connect a VCR for output from the computer, do the following:

- 1** Shut down the Macintosh and turn off the VCR.
- 2** Attach one end of the video cable to the Video In port on the VCR.

Follow the directions that came with the VCR.

- 3** Plug the other end of the video cable into either the S-video output port () or the yellow composite video output port () on the Macintosh.

If the S-video connector doesn't slide easily into the port, check the pin alignment and try again. Don't use force, which could damage the computer or cable.

- 4** Plug the RCA-type connectors on the audio cables into the left and right Audio In ports on the VCR.
- 5** Plug the RCA-type connectors on the audio cables into the left and right audio output ports () on the Macintosh.

If the cable is color-coded, the red connector is for the right port, and the black or white connector is for the left port.

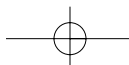

Depending on whether your equipment has S-video or composite video (RCA-type) ports, your finished connections should look like one of the following:

S-video connection for output from the computer

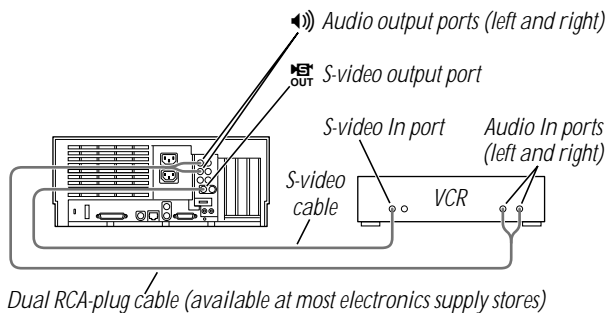

Composite video connection for output from the computer

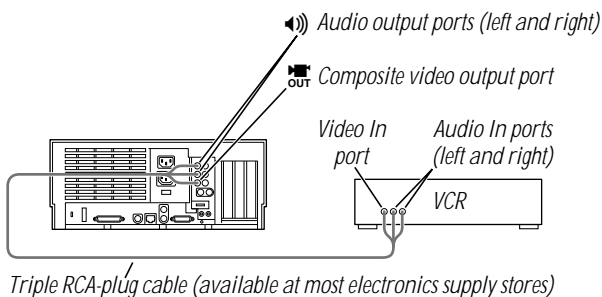

6 Turn on the computer and the VCR.

7 Select "line input" on your VCR.

See the manual that came with your VCR for instructions on how to select the line input source.

For further instructions on how to record the computer's output on videotape and add voice annotation, open Mac OS Help (available in the Help menu) and look for the information on saving computer images to videotape in the "Monitors" topic area.

Connecting a Television

You can connect to your computer any television that has either an S-video or composite video input port and Audio In ports. The television displays a mirror image of the computer monitor display, and (if the television has speakers) plays the sounds generated by the computer. This capability is especially useful for giving presentations if you have a large-screen television.

To connect a television for TV mirroring, first you turn off the computer and connect the television to it. Then you use the Control Strip to turn on TV mirroring. (If you need to learn more about the Control Strip, see Mac OS Help, available in the Help menu.)

Because TV mirroring uses a limited number of resolutions supported by televisions, it works best with multisynchronous monitors that support many resolutions. If you are using a fixed-frequency monitor, the monitor display will be disabled when you turn on TV mirroring. (Most newer monitors are multisynchronous; refer to the manual that came with your monitor if you are not sure.)

To connect a television and turn on TV mirroring, do the following:

- 1 Turn off your computer and connect the television according to the instructions in the previous section, "Connecting Video Equipment for Output From the Computer."

Depending on the type of connectors your equipment has (S-video or composite video), your connection should look like one of the following illustrations.

Television used as a monitor with an S-video connection

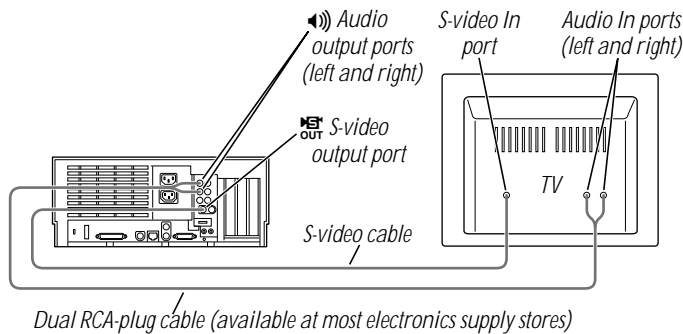

Television used as a monitor with a composite video connection

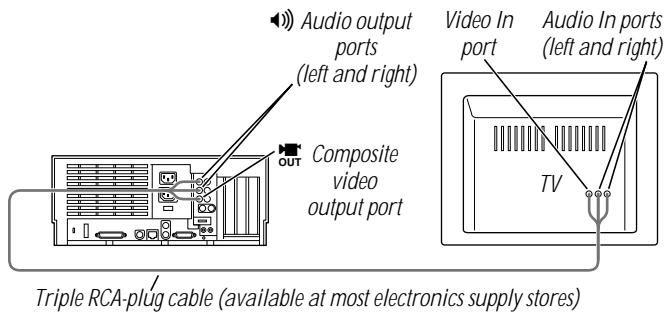

- 2** Turn on the television and the computer.
- 3** Click the TV Mirroring icon in the Control Strip, and choose Turn TV Mirroring On from the menu that appears.

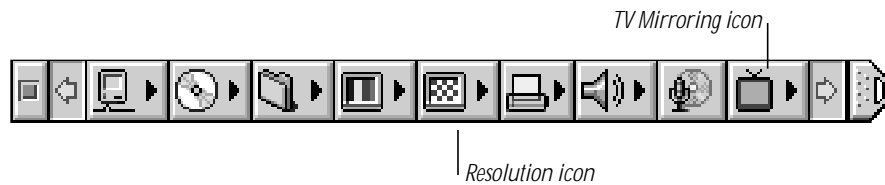

A message warns you to make sure a television is connected before continuing.

- 4** Click OK to close the message.
The screen resolution changes to one that is compatible with the television.
- 5** To improve the screen display of the monitor and the television, do one or more of the following:
 - Choose a different resolution from the Resolution icon in the Control Strip.
 - Choose a different Overscan setting from the TV Mirroring icon in the Control Strip.
When Overscan is turned on, the computer image fills the whole television screen, but the edges may not be visible. Turning off Overscan adds a black border around the computer image so that the entire computer image is visible on the television.
 - Choose the television standard supported by your television (either NTSC or PAL) from the TV Mirroring icon in the Control Strip.
 - Adjust the image controls such as brightness and contrast on the television.
 - To rearrange desktop icons that are no longer on the screen, click anywhere on the Finder desktop and choose Clean Up from the View menu.

To turn off TV Mirroring, click the TV Mirroring icon in the Control Strip, and choose Turn TV Mirroring Off from the menu that appears.

Power Macintosh AV Card Specifications

Video Input

- *Type:* composite or S-video
- *Standards supported:* NTSC, PAL, and SECAM
- *Resolution supported:* 320 x 240, which scales to any size up to the size of the monitor
- *Polarity:* sync negative
- *Voltage level:* 0.7 V_{pp} minimum, 1.0 V_{pp} typical, 1.4 V_{pp} maximum
- *Impedance:* 75 ohms (Ω) internally terminated

Video Output

- *Type:* composite and S-video
- *Standards supported:* NTSC and PAL
- *Resolutions supported:* 512 x 384, 640 x 480, 800 x 600, and 832 x 624
- *Polarity:* sync negative (no sync on S-video chroma signal)
- *Voltage level:* 1.0 V_{pp} \pm 5% into a 75 Ω resistive load (S-video chroma 0.7 V_{pp})
- *Impedance:* 75 Ω source

Sound input using the RCA-type audio input ports

- *Input impedance (preamplifier off):* more than 80 k Ω
- *Maximum input voltage (preamplifier off):* 1 V_{rms} = 2.8 Volts peak-to-peak (V_{pp}), nominal
- *Input impedance (preamplifier on):* more than 5 k Ω
- *Maximum input voltage (preamplifier on):* 62 millivolts (mV_{rms}) = 175 mV_{pp}, nominal

Sound output using the optional RCA-type audio output ports

- *Output impedance:* 400 Ω
- *Maximum output voltage:* 1 V_{rms} = 2.8 V_{pp}, nominal

Noise, distortion, and bandwidth

- *Audio input signal-to-noise ratio (SNR):* 85 decibels (dB) unweighted (add +8 dB to estimate A weighting)
- *Total harmonic distortion:* 0.05%
- *Bandwidth:* 20 Hz–20 kHz at 44.1-kHz sample rate (Other sample rates scale the upper cutoff frequency.)



Update: About Your Build-To-Order Macintosh

Congratulations on purchasing your Macintosh computer. Since you chose the components of your computer, parts of it may differ from what's described in the manual that came with it. This update addresses the differences and also includes information on additional components not covered in the manual.

10/100Base-T Network Connection

If your computer came with the 10/100Base-T Ethernet option, a 10/100Base-T Ethernet card is installed in one of your computer's PCI slots. You can connect a cable for a 10Base-T or a 100Base-T Ethernet network to this card.



10/100Base-T Ethernet port (RJ-45)

Note: The type of twisted-pair cable you use depends on whether you connect to 10Base-T or 100Base-T Ethernet. Category 5 twisted-pair cable must be used to connect to 100Base-T if you want to get the maximum speed from this connection.

Checking the Status of a 10/100Base-T Network Connection

If you connect your computer to a network using the 10/100Base-T Ethernet card, you can check the card's LED indicators to monitor network activity. There are four indicators:

- **ACT (Activity):** Blinks when the 10/100Base-T Ethernet card is active
- **COL (Collision):** Glows when a network collision has occurred (a temporary condition that occurs when two computers on a network try to send data simultaneously)
- **LNK (Link):** Glows when a reliable 10 megabit (Mbit) or 100 Mbit network connection has been established
- **100 Mb:** Glows when a reliable 100 Mbit link is established



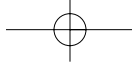

10/100Base-T Ethernet Card Specifications

- *Open Transport:* Mac OS 7.5.2 or later, AppleShare, AppleTalk, NetWare for Macintosh, TCP/IP
- *Connector:* RJ-45 (for 10Base-T and 100Base-T)
- *Media, 10Base-T:* Cat 3, 4, or 5 UTP on 2 pairs up to 100 meters (m)
- *Media, 100Base-T:* Cat 5 UTP on 2 pairs up to 100 m
- *Bus interface:* PCI revision 2.0 and 2.1, share interrupt A
- *Channel speeds:* IEEE Auto Negotiation of 10Base-T and 100Base-T
- *Communications:* IEEE 802.3u 100Base-T; IEEE 802.3i 10Base-T
- *Controllers:* DECchip 21140, 32-bit internal processor per channel
- *Power:* 1.2 amperes (A) @ 5 volts (V) typical

Ultra Wide SCSI Hard Disk Drive and PCI Card

If your computer came with an Ultra Wide SCSI hard disk drive, it includes some or all of the following components:

- an internal Ultra Wide SCSI hard disk drive
- in certain configurations, additional internal Ultra Wide SCSI hard disk drives
- an Ultra Wide SCSI card in one of your computer's PCI slots
- an internal Ultra Wide SCSI cable that supports up to three internal devices (including your pre-installed Ultra Wide hard disks)

Warning Do not connect any SCSI devices to the external 68-pin SCSI-3 connector or to the internal 50-pin SCSI-2 connector on the PCI card that supports the internal hard disk. Connecting even one external SCSI device to the external 68-pin connector extends the overall cable length of the SCSI bus beyond the limit for which error-free operation can be guaranteed; the combined length of the internal cable and the external cable reduces the reliability of all the devices connected to the Ultra Wide SCSI bus. Connecting a device to the internal 50-pin SCSI-2 connector will cause your Ultra Wide SCSI devices to transfer data at the slower, SCSI-2 rate.

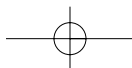

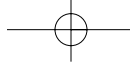

About the Ultra Wide SCSI Bus

Up to three internal devices can be connected to the Ultra Wide SCSI bus on this card.

All devices on the same SCSI bus must have unique ID numbers, but devices on different SCSI buses may use the same SCSI ID number. (For example, you could have a removable media drive with ID number 3 connected to the computer's built-in regular SCSI-1 bus and a hard disk with ID number 3 connected to the Ultra Wide SCSI-3 bus.)

The hard disks installed in your computer at the factory and the SCSI card have reserved certain SCSI ID numbers on the Ultra Wide SCSI bus. Other ID numbers are available for assignment to SCSI devices that are added later, as described in the following table.

Ultra Wide SCSI ID Number	Device
0	Factory-installed hard disk drive (terminated)
1 through 6	Available ¹
7	SCSI PCI card (terminated)
8 through 15	Available

¹ If your computer came with two or more Ultra Wide SCSI hard disk drives, use the System Profiler program (available in the Apple menu) to find out the SCSI ID numbers of your drives.

Important The factory-installed internal hard disk and the SCSI card are both terminated. Other SCSI devices that you install and connect to the Ultra Wide SCSI bus must not be terminated. If you attach a terminated device to the internal SCSI interface, the computer will malfunction.

You use the internal ribbon cable with the 68-pin connector to connect an internal SCSI device to the Ultra Wide SCSI bus.

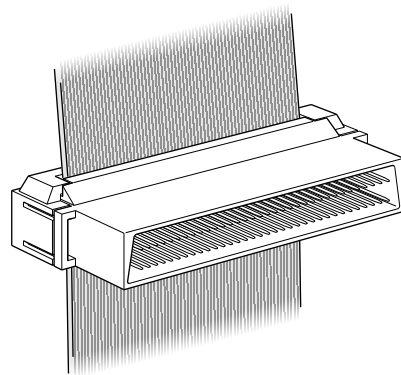

68-pin connector

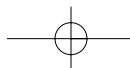

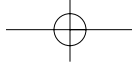

Ultra Wide SCSI Card Specifications

- Automatic termination
- Advanced Data Streaming Technology (ADS)
- RAID-ready
- Embedded RISC I/P processor
- Ultra SCSI connector: Fine pitch 68-pin "P"
- Flash ROM BIOS
- PCI 2.1 compliant
- Large command FIFO
- Supports disconnect/reconnect
- Asynchronous I/O support
- Multiple initiator support
- SCSI-3 tagged command queuing
- SCSI Manager 4.3 compatible

RAID Disk Volume Management Software

Certain Power Macintosh G3 configurations are supplied with RAID disk volume management software. This software enables your hard disk drives to be striped or mirrored.

The RAID CD can be used as a startup disk. You can restart from it and use the RAID application to initialize and stripe or mirror your hard disks. You can also use the RAID Installer to place a copy of the RAID application on one of your hard disks.

To restart your computer from the RAID CD, insert the CD and hold down the C key while you restart.

Refer to the documentation supplied on the RAID CD for full instructions on how to set up and maintain RAID volumes.

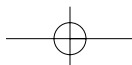

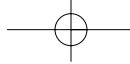

Using Disk Utilities and Formats With RAID

Important Drive Setup, the disk utility from Apple Computer, should not be used with RAID volumes. You must manage your RAID volumes using the RAID application.

To set up your RAID volumes to take advantage of Mac OS Extended (HFS Plus) format:

- 1 Create and set up your RAID volumes using the RAID application.
- 2 Quit the RAID application and return to the Finder.
- 3 Select the new RAID volume and choose Erase Disk from the Special menu to reformat the volume in Extended format.

Warning This process will erase all the data on your RAID volume. Be sure you back up your files before reformatting RAID volumes.

128-Bit 2D/3D Graphics Accelerator Card

If your computer came with an additional graphics card, you have the following options for connecting an external monitor to your computer:

- connect an external monitor to the built-in monitor port (shown in the manual that came with your computer)
- connect an external monitor to the graphics card installed in one of the PCI slots

There are two ports on the optional graphics card. One is the type found on the back of most Macintosh computers; the other is a VGA port so you don't need an adapter for a VGA monitor.

Note: You cannot use both ports on the optional graphics card at the same time.

- connect two external monitors to your computer

You can connect one monitor to the built-in monitor port and the other monitor to one of the ports on the graphics card, which is installed in one of the PCI slots.

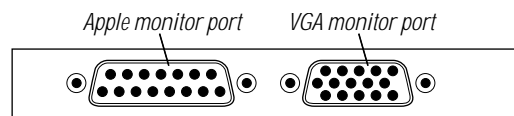

Important To capture video using the video input ports on the optional Power Macintosh Audio/Video card, a monitor needs to be connected to the built-in monitor port. If you have only one monitor connected to the optional 128-bit 2D/3D graphics accelerator card, you will not be able to capture video. If you want to capture video, switch your monitor to the built-in monitor port or connect a second monitor. When performing video capture with two monitors connected to your Power Macintosh, make sure that the video capture window is displayed on the monitor that is connected to the built-in monitor port.

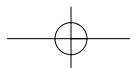

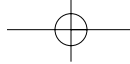

Display Modes and Color Depths

Resolution ¹	Color Depths	Vertical Refresh Rate (Hertz)
512 x 384	256, thousands, millions	60
640 x 480	256, thousands, millions	60, 67, 75, 85, 120
640 x 870	256, thousands, millions	75
800 x 600	256, thousands, millions	60, 72, 75, 85
832 x 624	256, thousands, millions	75
1024 x 768	256, thousands, millions	60, 70, 75, 85
1152 x 870	256, thousands, millions	75
1280 x 960	256, thousands, millions	60, 75, 85
1280 x 1024	256, thousands, millions	60, 75, 85
1600 x 1024	256, thousands, millions	76
1600 x 1200	256, thousands, millions	60, 65, 70, 75, 85
1920 x 1080	256, thousands, millions	60, 72
1920 x 1200	256, thousands	76

¹ The resolutions that appear in the Monitors & Sound control panel are dependent upon the type of monitor you are using.

Graphics Card Specifications

- 260 megabytes (MB) per second sustained image scroll rate
- 4.2 gigabytes (GB) per second sustained color fill rate
- Up to 1.2 million Gouraud shaded polygons per second
- 240 megahertz (MHz) RAM digital-to-analog converter (RAMDAC)
- 8 MB VRAM (*Note:* Additional VRAM cannot be added.)
- Supports QuickDraw 3D
- QuickTime video playback (video scaling and color space conversion handled in software)

Video Memory (SGRAM)

The manual *Setting Up Your Power Macintosh* and the *Technical Information* booklet state that your computer only has 2 MB of video memory built into the computer's main logic board and that you can add video memory by installing a Small Outline (SO) Dual Inline Memory Module (DIMM) in a slot on the logic board. However, if your computer came with 6 MB of video memory, a 4 MB SO-DIMM has already been installed in the expansion slot on the logic board. You will not be able to add any more video memory.

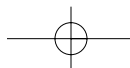

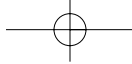

Apple FireWire Card

The optional Apple FireWire Card is designed to work with digital video camcorders and decks that use the DV format and have a FireWire port (sometimes marked IEEE 1394 or DV IN/OUT). The included hardware and software, together with a non-linear editing application, allow you to capture DV movie clips to your hard disk. You can view the clips in MoviePlayer or other QuickTime 3.0 applications, and edit and render the DV movies. If you are using a video editing application with an export function, you can send (print or record) movies back to the tape in your camcorder or deck. The software also allows the FireWire device to be controlled from the computer.

The FireWire Bus

FireWire is a serial bus that can support high-performance devices, such as DV cameras and printers. Devices can be connected in any combination of branching and chaining, as long as no loops are formed. A FireWire bus can support up to 16 consecutive cable hops of 4.5 meters each. There are no SCSI-style ID numbers to set and no termination requirements.

The Apple FireWire Card is designed to keep the network alive even if the Macintosh is shut down. Loss of power to the Macintosh will not affect the operation of a FireWire card as long as it can draw power from other cards on the bus.

Each card provides power which is available to other devices on the network. This means that a system shutdown will not result in interrupted transmission over a FireWire network.

Important For more information about cable management and power issues, please refer to the FireWire ReadMe file on the FireWire CD.

Apple FireWire Hardware

If you ordered the Apple FireWire Card with your computer, you have received the following items:

- the Apple FireWire Card, installed in one of your computer's PCI slots
- a FireWire cable, 4-pin to 6-pin, 2 meters long
- a FireWire software installation CD

Your Apple FireWire Card has three FireWire ports, as shown in the following illustration.

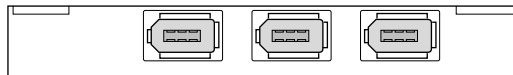

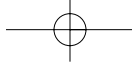

To connect your Macintosh to a DV camera, plug the 6-pin connector into the Apple FireWire Card and the 4-pin connector into the camera's DV port. Both of these connectors snap into place when properly engaged. If you want to connect two computers together (or if your device has a 6-pin FireWire port), you can obtain cables through an AV equipment retailer or electronics store.

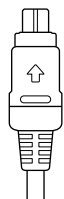

4-pin 1394 (FireWire) connector 6-pin 1394 (FireWire) connector

Apple FireWire Card Software

To install the Apple FireWire Card software:

- 1** Insert the FireWire CD.
- 2** Double-click the Installer icon.
- 3** Follow the onscreen instructions.
- 4** Restart your computer.

Important An extension called FireWire Support may be located in a folder titled FireWire in the Apple Extras folder on your Macintosh. Do not move this older extension to your Extensions folder, as it may interfere with the operation of the new Apple FireWire software.

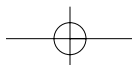



DVD-ROM Drive

If you chose the DVD-ROM option for your computer, you have a DVD-ROM drive in place of the CD-ROM drive. This type of drive is used in the same way as a CD-ROM drive, but allows you to use a wider range of disc formats:

- DVD-ROM
- CD-ROM (Modes 1 and 2)
- CD-ROM XA (Mode 2, Forms 1 and 2)
- CD-I (Mode 2, Forms 1 and 2)
- CD-Audio
- Photo CD
- video CD

Disc speeds and capacities vary depending upon the type of disc used.

Note: This DVD-ROM drive supports the use of DVD movie titles. However, third-party MPEG-2 hardware is required for actual playback.

